

SECTION C

49000 BUMPERS

CONTENTS

Division	Paragraph	Subject	Page
I	140-3	SPECIFICATIONS AND ADJUSTMENTS: Adjustment of Front and Rear Bumper	140-10
II		DESCRIPTION AND OPERATION:	
III		SERVICE PROCEDURES: Removal and Installation Obvious Upon Inspection. See Illustrations.	
IV		TROUBLE DIAGNOSIS:	

DIVISION I SPECIFICATIONS AND ADJUSTMENTS

140-3 ADJUSTMENT OF FRONT AND REAR BUMPER

The front bumper brackets and supports are slotted to allow alignment to adjacent parts. The rear bumper brackets and braces are also slotted to permit alignment.

INDEX OF ILLUSTRATIONS

Figure Number	Description	Page
140-7	49000 Front Bumper	140-11
140-8	49000 Rear Bumper	140-12

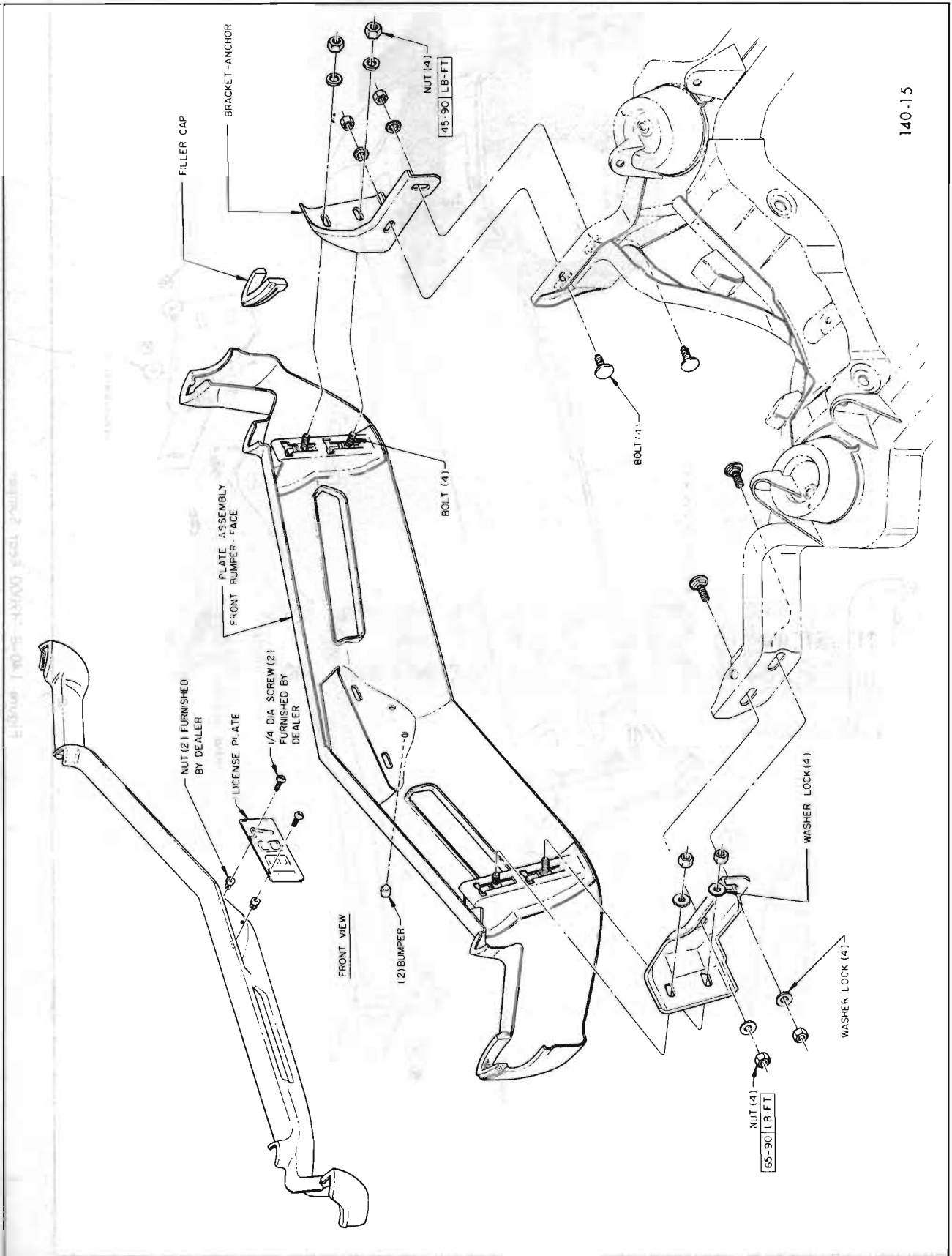

140-15

Figure 140-7 49000 Front Bumper

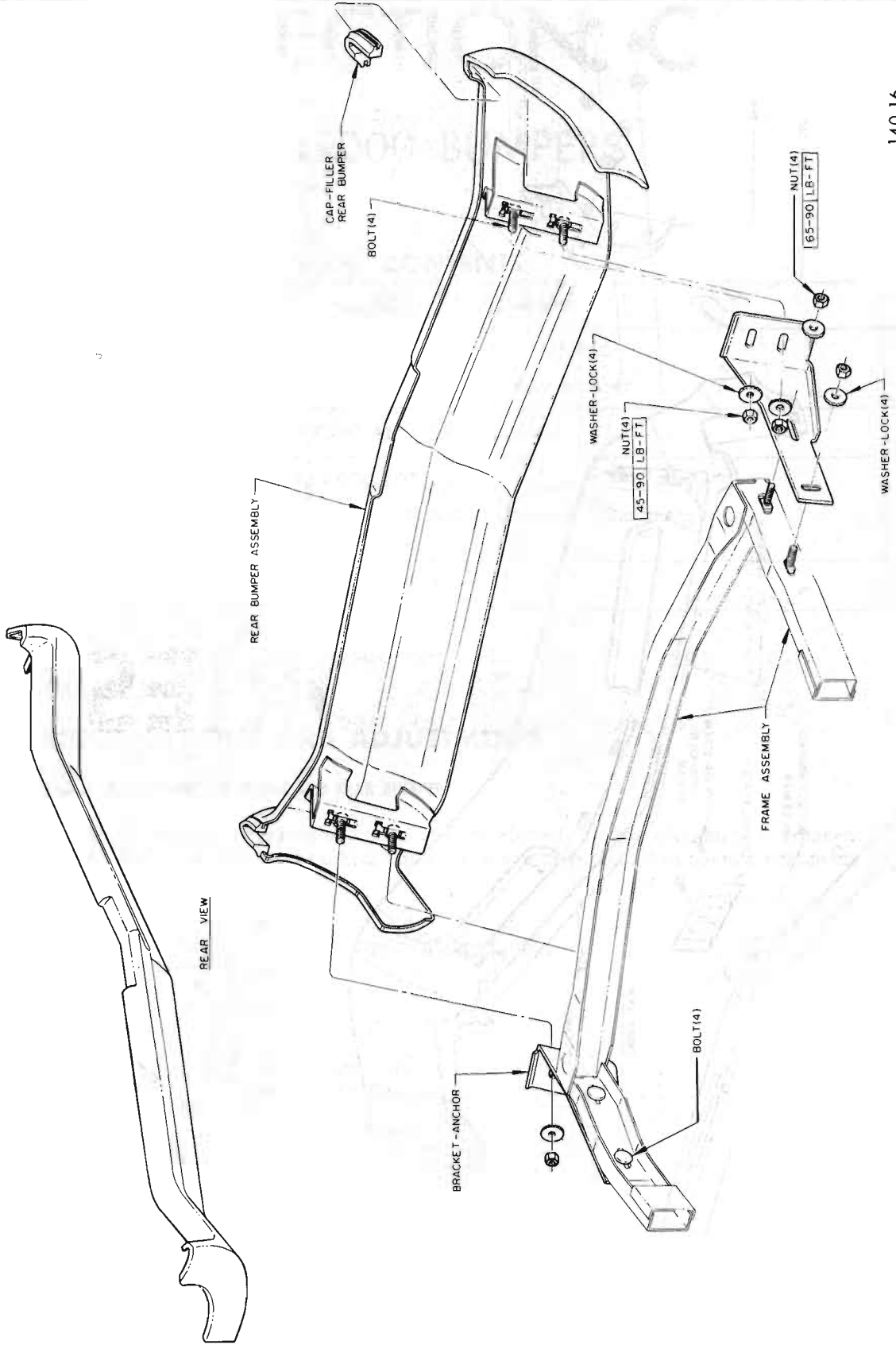

Figure 140-8 49000 Rear Bumper