

## SECTION 5-B HYDRAULIC CONTROLS

### CONTENTS OF SECTION 5-B

Paragraph	Subject	Page	Paragraph	Subject	Page
5-5	Oil Pump and Pressure Regulator . . . . .	5-17	5-7	Transmission Assembly Removal and Installation . . . . .	5-30
5-6	Hydraulic Controls . . . . .	5-18	5-8	Adjustments on Car . . . . .	5-31

### 5-5 OIL PUMP AND PRESSURE REGULATOR

#### a. Oil Pumps

A positive displacement internal-external gear type oil pump is used to supply oil to fill the converter, for engagement of the forward and reverse clutches for application and release of the low band and to accumulate oil for lubrication and heat transfer.

#### b. Main Pressure Regulator Valve

The pressure regulator valve located in the pump cover is used as the basic control of hydraulic pressure within the transmission.

##### 1. First Stage Regulation

When the engine is idling or has

just been started, oil enters the main pressure regulator valve assembly between the first and second lands and flows through interconnecting drilled holes in the valve to occupy the space between the third land and the oil pump cover. Oil under pressure between the third land and the pump cover moves the valve against its spring to uncover the port which directs oil to the converter and thence to the oil cooler and lubrication systems of the transmission. Figure 5-14 shows the pressure regulator valve in first stage regulator position.

##### 2. Second Stage Regulation

As higher engine speeds are attained, the volume of oil leaving the pump increases until the valve moves to the position shown in Figure 5-15 which opens a port to allow main line oil to escape

to suction to regulate pressure. Second state regulation is only necessary during operation at high speeds or operations with cold oil.

##### 3. Boost Valve

A boost valve at the spring end of the pressure regulator valve functions to raise line pressure when necessary by adding hydraulic pressure to the spring pressure on the main pressure regulator valve.

##### 4. Modulator Boost

With the manual shift control valve positioned in drive range, oil under pressure varied by operating conditions (load, car speed, grade, etc.) is directed to the space between the first land of the boost valve and the valve body. Oil under pressure in this space has the same effect as increasing the spring pressure against the pressure regulator valve, that is, it increases main line oil pressure.

##### 5. Reverse Boost

With the manual shift control valve positioned in reverse range, oil under pressure is directed to the space between the first and second lands of the boost valve. Since the second land is larger than the first, the boost valve bears on the spring end of the pressure regulator valve adding

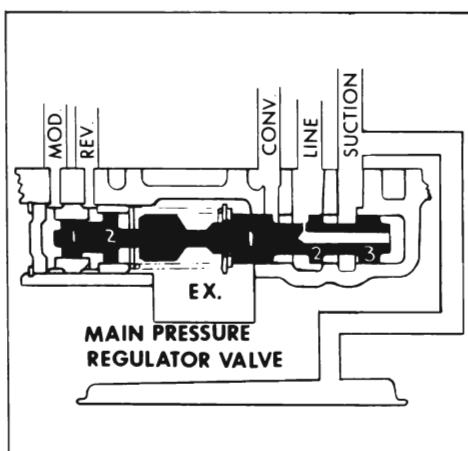

Figure 5-14—Pressure Regulator Valve (First Stage Regulation)

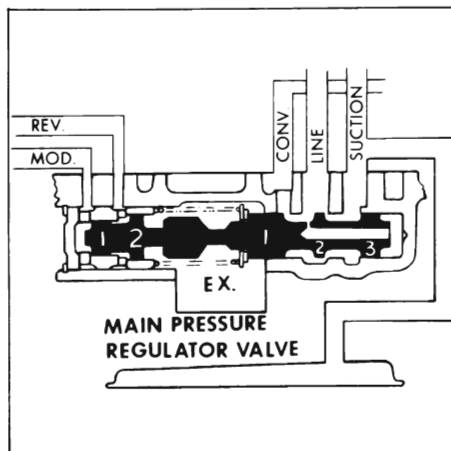

Figure 5-15—Pressure Regulator Valve (Second Stage Regulation)

to the spring pressure of the valve, thus increasing mainline oil pressure for operation in reverse range.

**5-6 HYDRAULIC CONTROLS**

The hydraulic control system consists of the following main components:

- Manual Shift Control Valve
- Stator Control Valve
- Shift Valve and Shift Control Valve
- Vacuum Modulator Valve
- Governor Valve
- Modulator Limit Valve
- Detent Valve
- High Speed Downshift Timing Valve
- Coast Downshift Timing Valve

**a. Manual Shift Control Valve**

The manual shift control valve in the valve body routes oil to the controlling devices that govern operation in Drive, Low and Reverse. In Neutral and Park ranges, the manual control valve cuts off oil pressure to the low servo and forward clutch. See Figure 5-16. The manual shift control valve is connected by mechanical linkage to the manual control lever on the steering column.

**b. Stator Control Valve**

The stator control valve is a spring load valve located in the

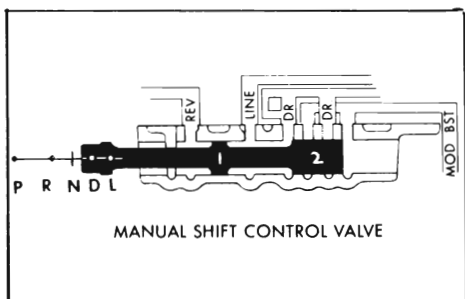

Figure 5-16—Manual Shift Control Valve

stator control valve body. The function of this valve is to control high or low angle of the stator blades. See Figures 5-17-5-18. The action of the valve is affected by spring pressure and a solenoid valve. When the stator control valve solenoid is energized the valve plunger is retracted, uncovering an exhaust port through which oil may escape from the spring side of the stator control valve. Oil thus escaping allows oil at converter charging pressure to move the valve against its spring. With the stator valve positioned against the valve plug no oil is directed to the front of the stator blade piston and converter charging pressure then moves the piston (connected to the stator blade cranks) to shift the blades to high angle. See Figure 5-17.

**c. Shift Valve and Shift Control Valve**

The shift valve and shift control valve are housed together in the main valve body. They interpret

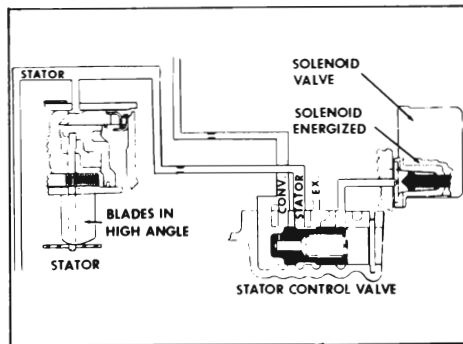

Figure 5-17—Stator Blades in High Angle

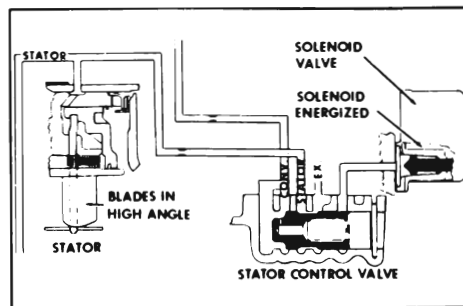

Figure 5-18—Low Angle

oil pressure from the governor and vacuum modulator valve to the shift from automatic low (manual shift control valve in drive range) to drive range or from drive to automatic low range.

**1. Upshift from automatic low range to drive range**

As the car is accelerated from a stop the shift valve and shift regulator valve are positioned as shown in Figure 5-20. The shift valve is held against the end of its bore by the force of a spring and the pressure exerted on the end of the shift regulator valve. With the shift valve thus positioned no oil under pressure is directed to the high clutch piston or spring side of the low servo piston, thus the low band is applied and the transmission is in low range.

When the proper relationship between car speed and throttle opening exists, governor oil pressure against the first land of the shift valve will overcome spring pressure and the force of limited modulator oil pressure against the shift regulator valve and move both valves to the right as shown in Figure 5-21.

With the valves thus positioned, oil under pressure is directed to the forward clutch piston and the spring side of the low servo piston.

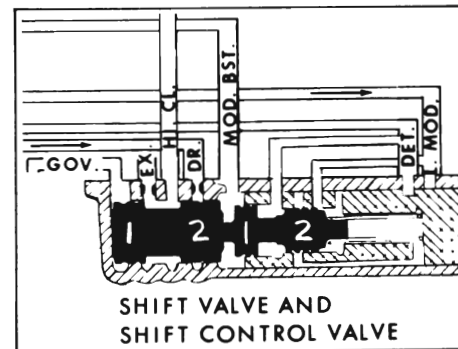

Figure 5-20—Automatic Low

## 2. Downshift from drive to low

When detent pressure against the shift regulator valve in combination with the spring reaches a value sufficient to overcome governor valve pressure against the first land of the shift valve, both valves move to the shift valve end of the bore and the transmission is downshifted by exhausting oil under pressure to the high clutch and spring side of the low servo piston. See Figure 5-20.

## 3. Manual Low

With the manual shift control valve positioned in low (L) range oil under pressure is directed to the space between the shift valve and the shift regulator valve. Oil under pressure in this space moves the shift valve to the end of its bore. With the shift valve thus positioned no oil under pressure is directed to the high clutch piston or spring side of the low servo piston, thus the low band is applied and the transmission is in low range. See Figure 5-22.

### d. Vacuum Modulator and Valve

The vacuum modulator and valve assembly is a device to translate load (engine manifold vacuum), barometric pressure (altitude) and speed (governor valve oil pres-

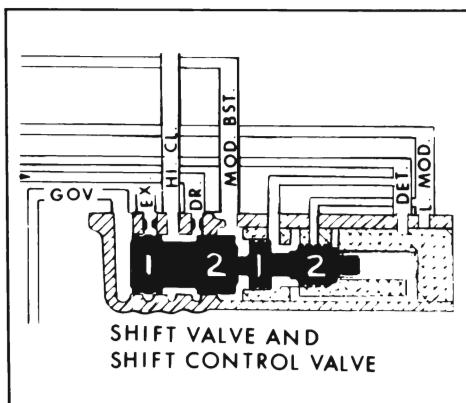

Figure 5-21—Up-Shifted

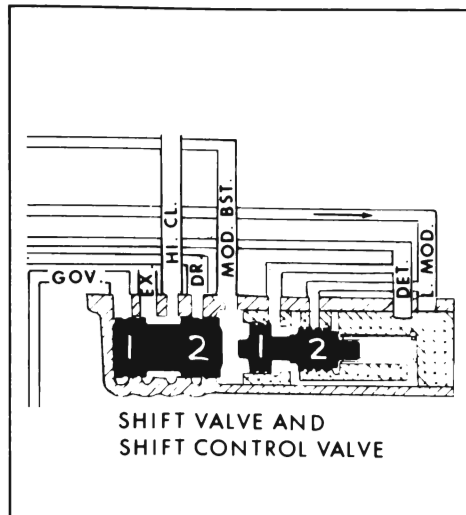

Figure 5-22—Manual Low

sure) into modulated oil pressures to regulate main line oil pressure at an efficient value.

Main line oil enters the valve between the first and second lands of the valve, flows through the drilled ports to the space between the first land and the valve body. Here, the oil when it reaches sufficient pressure moves the valve against its spring to regulate the exit oil (called modulator oil).

### 1. Manifold vacuum effect

The modulator valve spring is housed in a sealed container in such a way that engine manifold vacuum may act upon it to reduce the force of the spring against the valve and thus affect modulator oil pressure. Conditions of load or grade that lower manifold vacuum increase modulator oil pressure, while high manifold vacuum decreases modulator pressure. See Figure 5-23.

### 2. Altitude or barometric pressure effect

If the car is operated at high altitudes where barometric pressure is reduced the aneroid device in the vacuum modulator housing expands and acts against the valve spring to reduce modu-

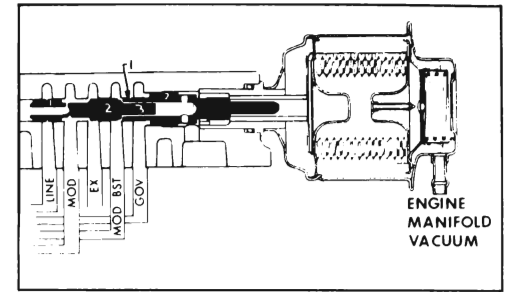

Figure 5-23—Vacuum Modulator and Valve

lator oil pressure in proportion to the barometric pressure.

At high altitudes engine output is reduced. Comparable reduction in transmission main line oil pressure is necessary to accomplish smooth shifts under these conditions.

### 3. Governor effect

As car speed increases governor valve oil pressure increases (up to the limit of the valve as described in subpar. e below). Oil at governor valve pressure bearing on the fourth land of the vacuum modulator valve has the effect of reducing the spring pressure against the valve, thereby reducing modulator oil pressure as governor pressure (car speed) increases.

### 4. Modulator boost effect

With the manual shift control valve positioned in Low (L) range, oil at main line pressure bears against the second land of the modulator valve which separates the two pieces of the valve and tends to move the valve to the bottom of its bore independent of the valve spring. Thus, modulator oil under pressure is directed to the main line pressure regulator valve to provide an increase in main line oil pressure in low range, regardless of engine vacuum. If driving conditions result in low engine vacuum however, the valve spring will move the two sections of the valve back

together. Then both the valve spring and the pressure of main line oil against the second land of the valve will regulate modulator oil pressure.

### e. Governor Valve

The governor valve is a pressure regulator valve the output of which is determined by car speed acting through the centrifugal force of a pair of dual weights; the inner pair of which is spring loaded. See Figure 5-24.

As the car begins to move the weight assemblies move outward to provide a regulating force against the valve through the springs between the primary and secondary weights. As car speed is further increased, regulating force against the valve is provided by the secondary weights moving outward. At approximately 35 MPH the primary weights have reached the limit of their travel and the force against the valve is then entirely through the secondary weights.

Thus governor valve pressure is determined at very low speeds by the primary weights at intermediate speeds by the springs between the weights and at higher speeds by the secondary weights. In this manner governor pressure is increased rapidly but smoothly from very low speeds

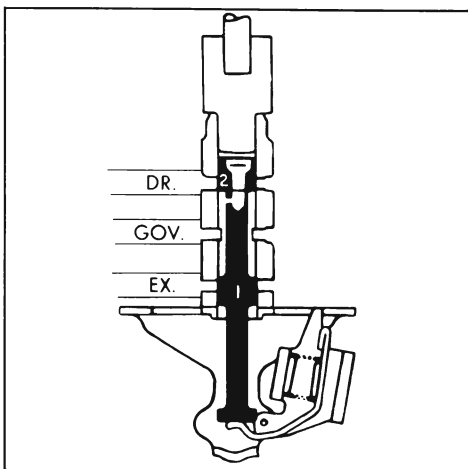

Figure 5-24—Governor Valve

to approximately 40 MPH, where it increases at a slower rate.

Regulated oil from the governor valve is channeled to the shift valve, vacuum modulator valve, modulator limit valve, and high speed down shift timing valve.

Governor pressure thus determines or affects shift points, main line oil pressure, and down shift timing.

### f. Modulator Limit Valve

The modulator limit valve is a pressure regulator valve that regulates the point at which a wide open throttle up shift will occur.

The valve regulates limited feed oil (main line pressure) to provide diminishing oil pressure bearing against the shift control valve as car speed is increased. This decrease in oil pressure is accomplished by governor valve pressure bearing on the third land of the valve and acting to diminish spring pressure as car speed (governor valve pressure) increases. See Figures 5-25 and 5-26.

The modulator limit valve is in operation only before the upshift during wide open throttle operation with the manual shift control valve in Drive position.

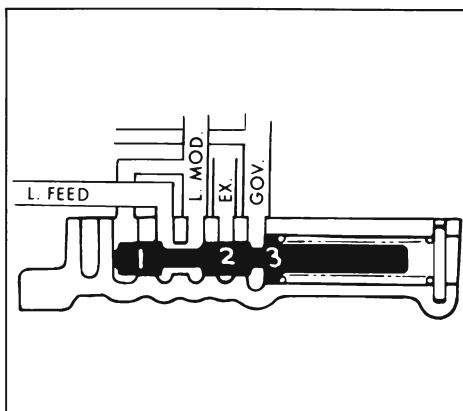

Figure 5-25—Modulator Limit Valve (First Stage)

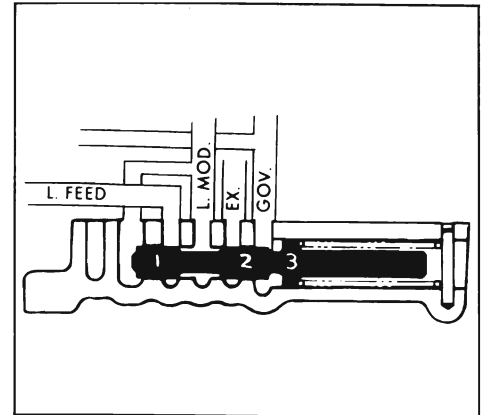

Figure 5-26—Modulator Limit Valve (Second Stage)

### g. Detent Valve

The detent valve is a solenoid operated two position valve that provides a downshift at wide open throttle if car speed is low enough.

Electrical contacts on the carburetor linkage energize the detent solenoid as wide open throttle is reached. Energization of the solenoid retracts its plunger and allows oil from the center of the valve to flow to exhaust. Main line oil pressure against the first land and end of the valve moves the valve against its spring as shown in Figure 5-27.

With the valve in this position, ports are opened to allow oil at main line pressure flow to the modulator limit valve and limited modulator oil to flow to the detent port of the shift control valve. When the solenoid is de-energized the spring loaded plunger seals the port in the valve center. Oil

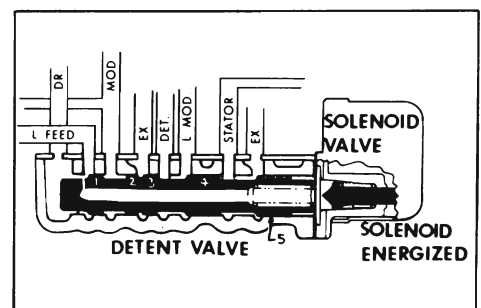

Figure 5-27—Solenoid Valve Energized

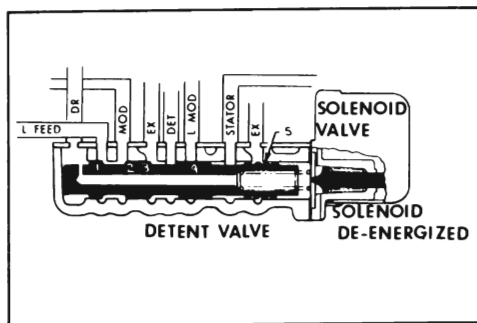

Figure 5-28—Solenoid Valve De-Energized

at main line pressure then occupies the center of the valve and bears against the fifth land of the valve as well as the first land. The detent valve spring then moves the valve to the position shown in Figure 5-28, shutting off the modulator, detent and limited modulator ports.

#### h. High Speed Down Shift Timing Valve

The high speed downshift timing valve is a spring loaded valve located in the main valve body. Its function is to control the rate of low servo application at high road speeds.

At sufficiently high road speeds governor pressure against the first land of the valve overcomes spring pressure to move the valve to the position shown in Figure

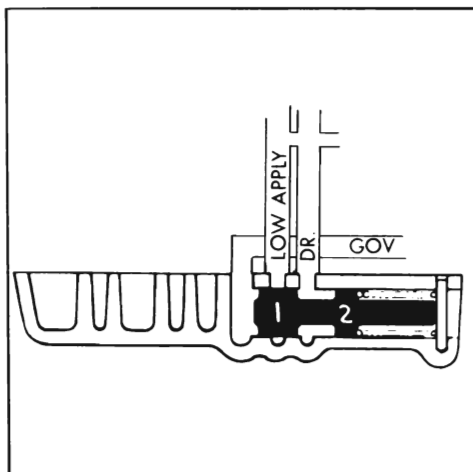

Figure 5-29—High Speed Downshift Timing Valve

5-29. With the valve in this position oil for low servo application must pass two orifices as shown. At lower car speeds, governor valve pressure is not sufficient to overcome the spring pressure and low servo application is made through passages containing one orifice as shown in Figure 5-30.

#### i. Coast Down Shift Timing Valve

As the car is decelerating with closed throttle or very light throttle (such as when approaching a stop) governor valve pressure diminishes to a point where spring pressure moves the shift valve to the down shift position. When this occurs, oil is exhausted from the band release chamber of the low servo through the coast down shift timing valve

A rush of oil through the valve moves the ball retainer and ball against light spring pressure off its seat, oil may then escape around the ball retainer and spring. This action cushions the initial engagement of the low band. See Figure 5-31.

#### j. Operation of Hydraulic Controls in Drive Range (Part Throttle Upshifted)

During operation in Drive range the manual shift control valve is positioned as shown in Figure 5-32. During part throttle acceleration main line oil is directed to the modulator valve and manual shift control valve. Main line oil entering the manual shift control valve is routed into the drive oil passage and then directed to the governor valve, shift valve, detent valve, high speed down shift timing valve and low servo.

Main line oil being directed to the modulator valve enters between the first and second lands. At low

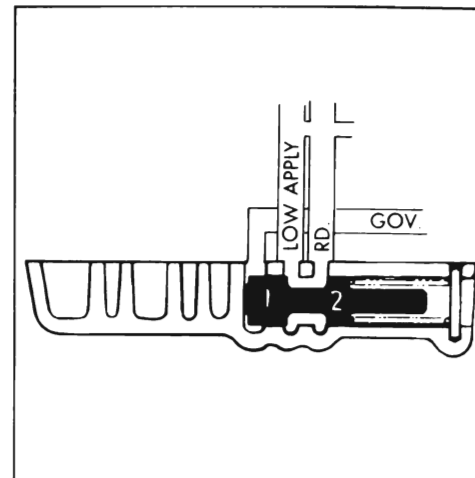

Figure 5-30—High Speed Downshift Timing Valve Regulated

engine vacuum the vacuum modulator tends to keep the valve toward the bottom of its bore. In this position oil is delivered through a drilled passage in the valve to the space between the first land of the valve and the valve body. Oil under pressure in this area plus governor pressure on the second land of the second modulator valve tends to move the valve against the force of its spring to regulator modulator oil pressure leaving the valve. Modulator oil leaves the modulator valve and is routed to the boost valve, detent valve, modulator limit valve, and to the second land of the shift control

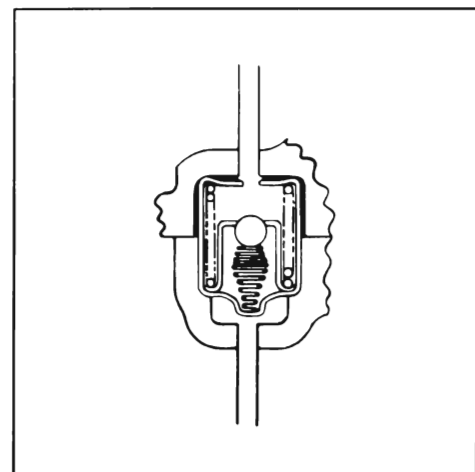

Figure 5-31—Coast Down Shift Timing Valve



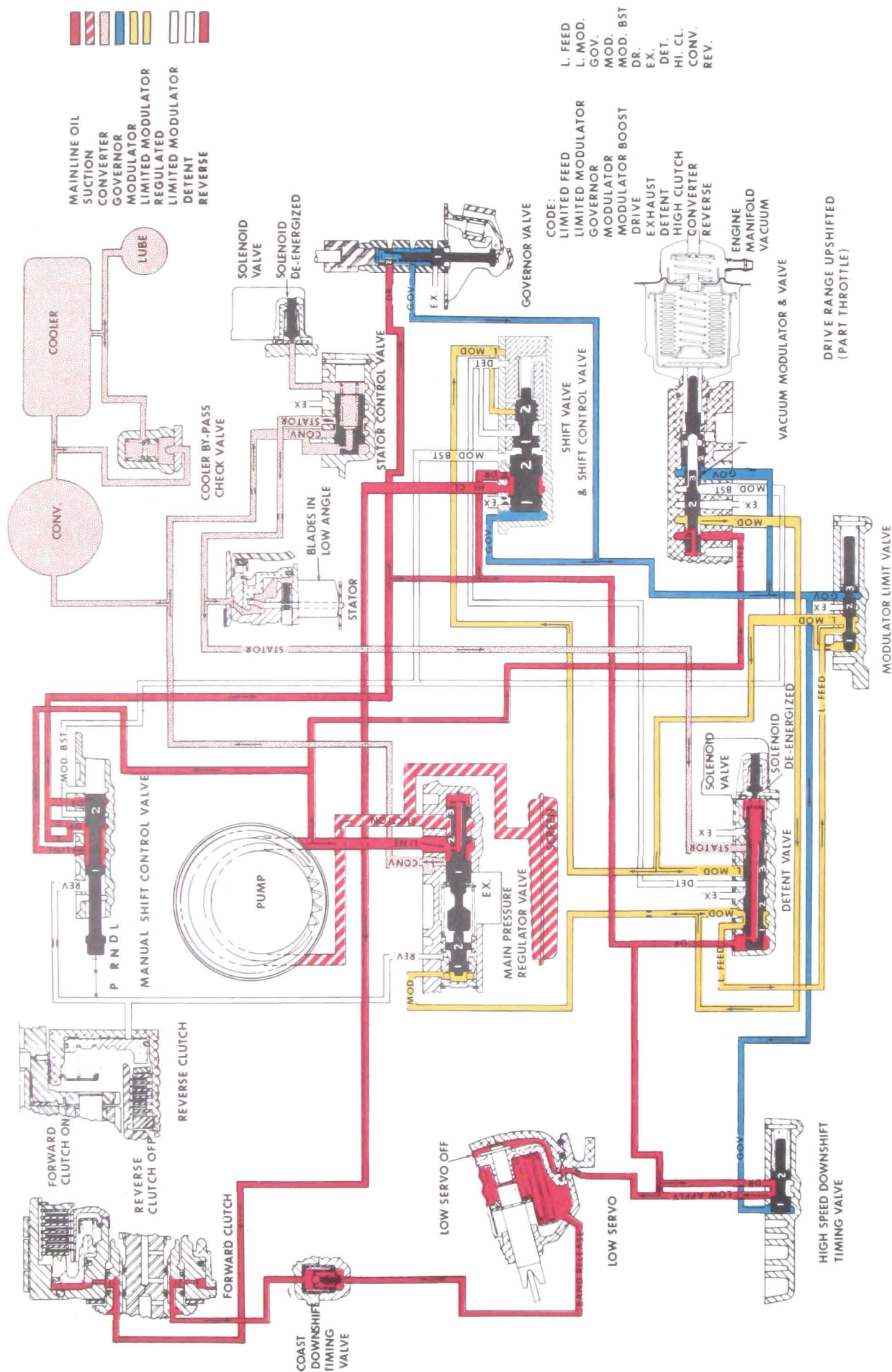

Figure 5-32—Drive Range Upshifted (Part Throttle)

valve. Modulator pressure applies a force to the space between the first land of the boost valve and the oil pump body causing it to move to the right in Figure 5-32. As the boost valve moves to the right it contacts the pressure regulator valve. This hydraulic force combined with normal spring force on the pressure regulator valve results in higher main line pressure. Also modulator pressure is routed through the detent valve and modulator limit valve to the shift control valve.

When sufficient car speed has been obtained, the governor valve will move allowing drive oil to be directed at regulated pressure to the space between the first land of the shift valve and the valve body and between second and third lands of the modulator valve, between the second and third lands of the modulator limit valve and in the space between the first land of the high speed down shift timing valve and the valve body. As governor pressure is received between the second and third lands of the modulator valve it will tend to move the valve against its spring, reducing modulator pressure.

When governor pressure reaches a high enough value the shift valve will move to the right allowing drive oil to apply the forward clutch and release the low band.

#### **k. Operation of Hydraulic Controls in Drive Range (Full Throttle to Detent Switch Pitch Only)**

During operation in Drive range at full throttle to detent switch pitch only, the stator control solenoid is energized. See Figure 5-33.

Main line oil passes through the pressure regulator valve to the converter and stator control valve. Energization of the stator

control solenoid allows oil from the center of the valve to flow to exhaust. Converter oil pressure against the valve body and the first land of the valve moves the valve against its spring until it bottoms in its bore. When the valve reaches the bottom of its bore it will exhaust the stator, switching the blades to high angle.

Main line oil entering the manual shift control valve is routed into the drive oil passage and then directed to the governor valve, shift valve, detent valve, high speed down shift timing valve and low servo. Main line oil directed to the modulator valve enters between the first and second lands. At low engine vacuum, the vacuum modulator tends to keep the valve toward the bottom of its bore. In this position, oil is delivered through a drilled passage in the valve to the space between the first land of the valve and the valve body. Oil pressure in this area plus governor pressure on the second land of the second modulator valve will tend to move the valve against the force of its spring to regulate modulator oil pressure leaving the valve. At the same time, line oil pressure enters the area between the first and second lands of the modulator valve and into the modulator pressure line. Modulator oil leaves the modulator valve and is routed to the boost valve, detent valve, modulator limit valve, and to the shift control valve. Modulator pressure applies a force to the space between the first land of the boost valve and the oil pump body causing it to move to the right in Figure 5-33. As the boost valve moves to the right it contacts the pressure regulator valve. This hydraulic force combined with normal spring force on the pressure regulator valve results in a higher main line pressure. Also limited modulator pressure is routed through the detent valve and to the modulator limit valve. Limited

modulator from the modulator limit valve is routed to the shift control valve.

When sufficient speed is obtained, the governor valve will move, allowing drive oil to be directed at reduced pressure to left end of the shift valve and between the second and third lands of the modulator valve, between the second and third lands of the modulator limit valve and at the left end of the high speed down shift timing valve. As governor pressure is received between the second and third lands of the modulator valve it will tend to move the valve to the right, reducing modulator pressure. When governor pressure reaches a high enough value, the shift valve will move to the right allowing drive oil to apply the forward clutch.

#### **l. Operation of Hydraulic Controls in Drive Range (Full Throttle Detent and Switch Pitch)**

During operation in Drive range at full throttle detent and switch pitch, both the stator control valve and detent valve solenoids are energized. The manual shift control valve is positioned as shown in Figure 5-34.

Main line oil passes through the pressure regulator valve to the converter and detent valve. When the stator control valve solenoid is energized it allows oil from the center of the valve to flow to exhaust. Converter oil applying force to the area between the valve body and the first land of the valve moves the valve against its spring pressure to the bottom of its bore.

When the valve reaches the bottom of its bore it will exhaust the stator, switching the pitch to high angle. Converter pressure oil applies force to the area between the valve body and the first land

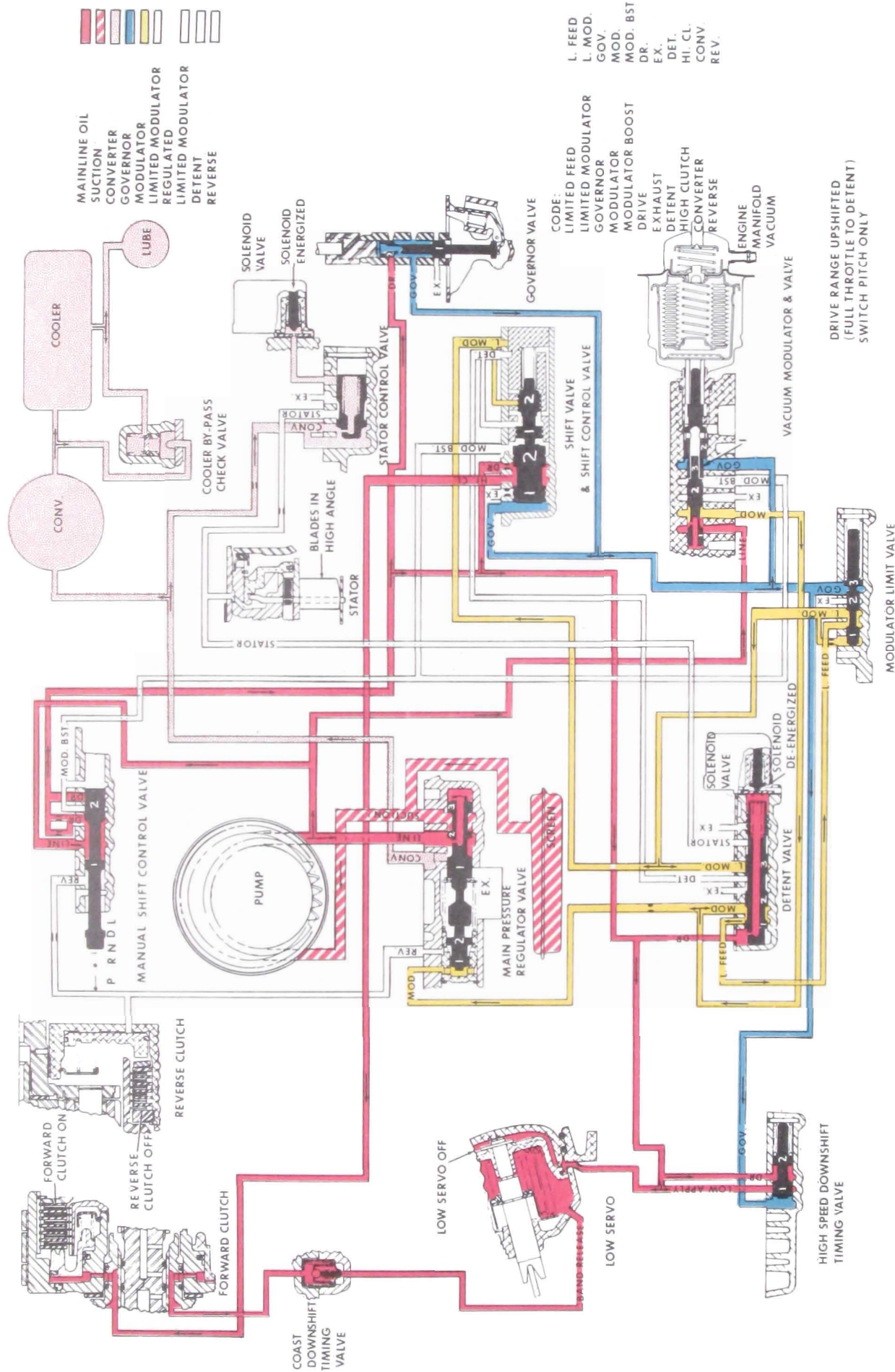

Figure 5-33—Drive Range (Full Throttle to Detent Switch Pitch Only)



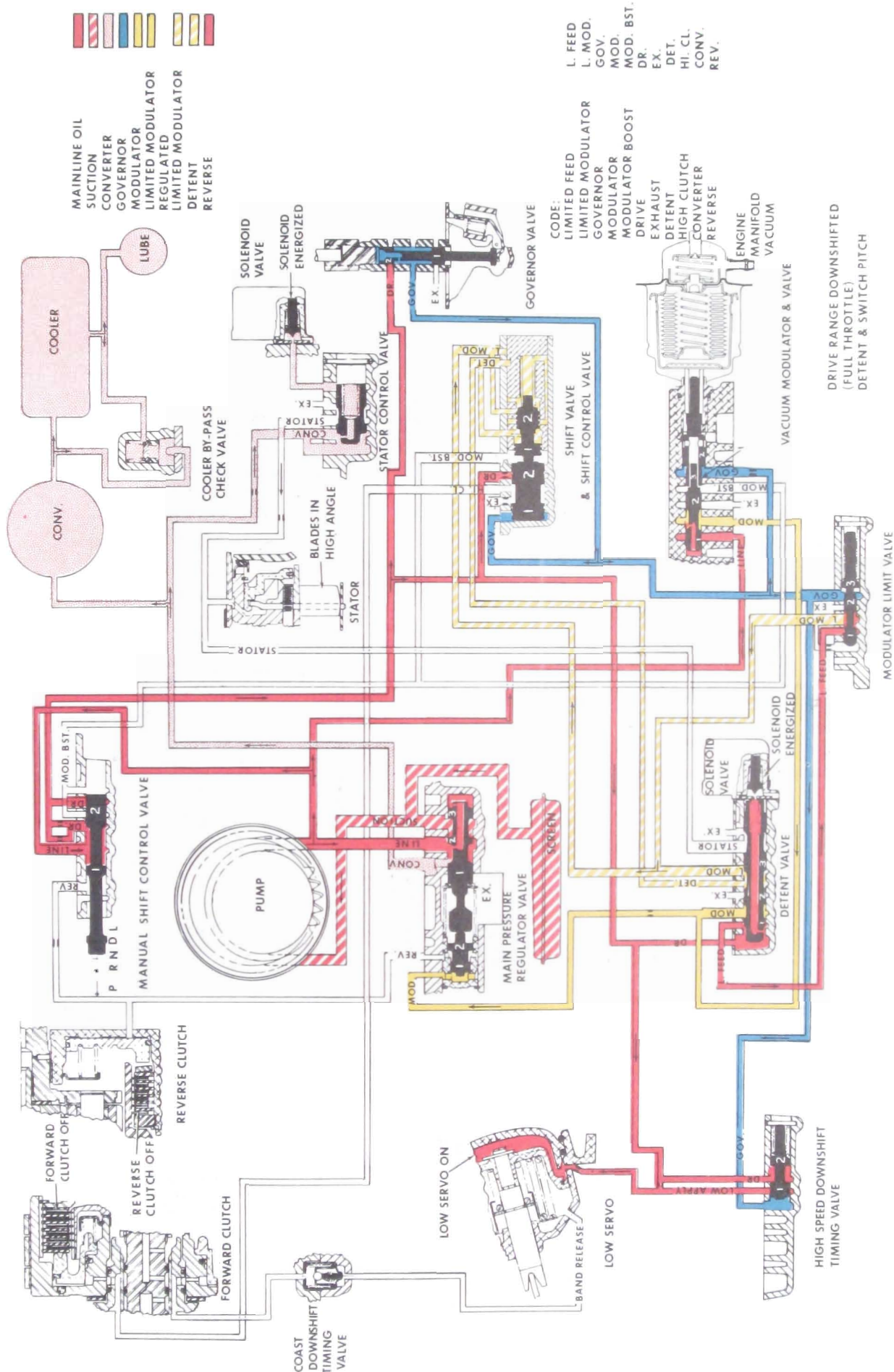

Figure 5-34—Drive Range (Full Throttle to Detent and Switch Pitch)

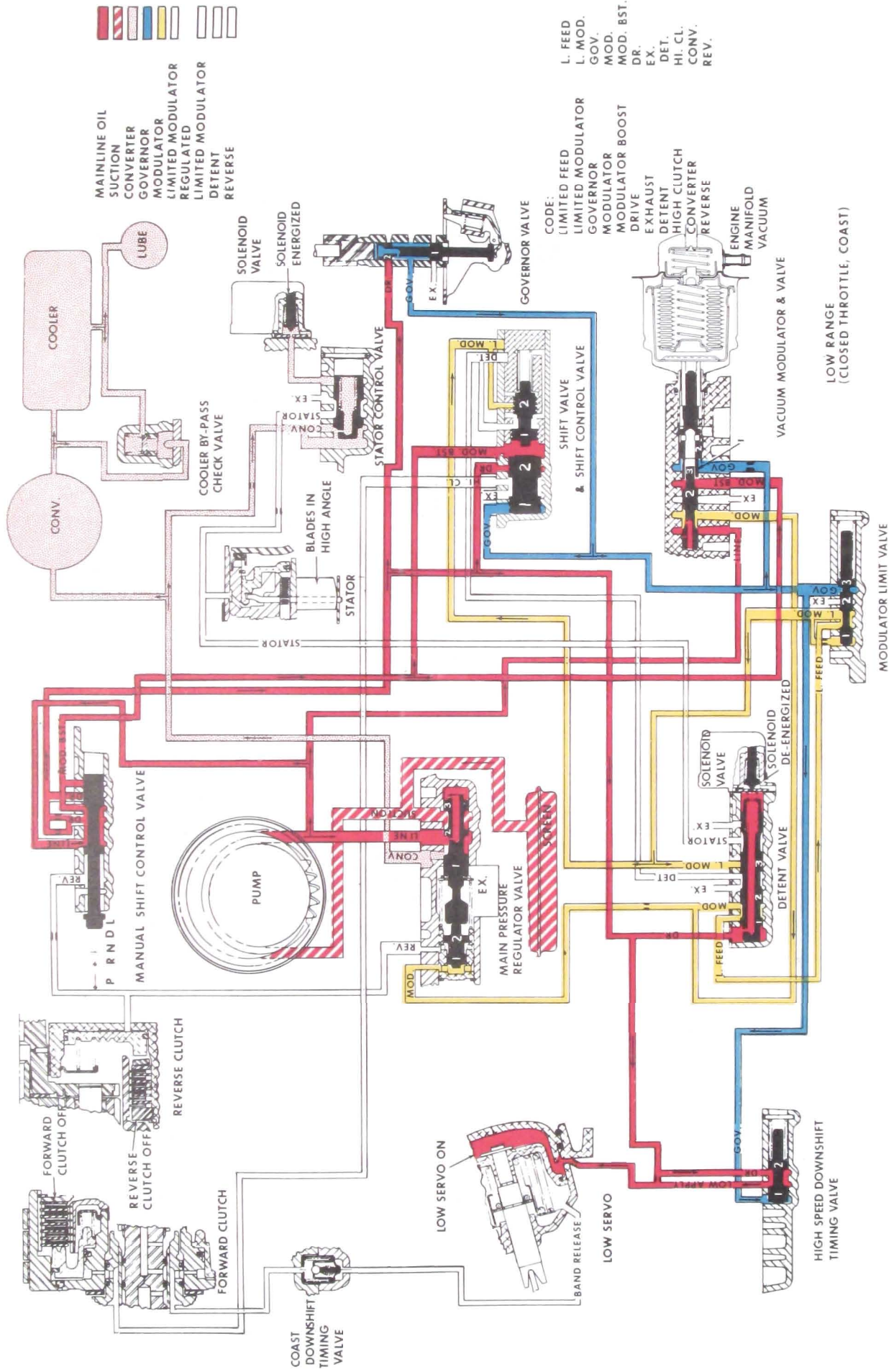

Figure 5-35—Low Range (Closed Throttle Coast)



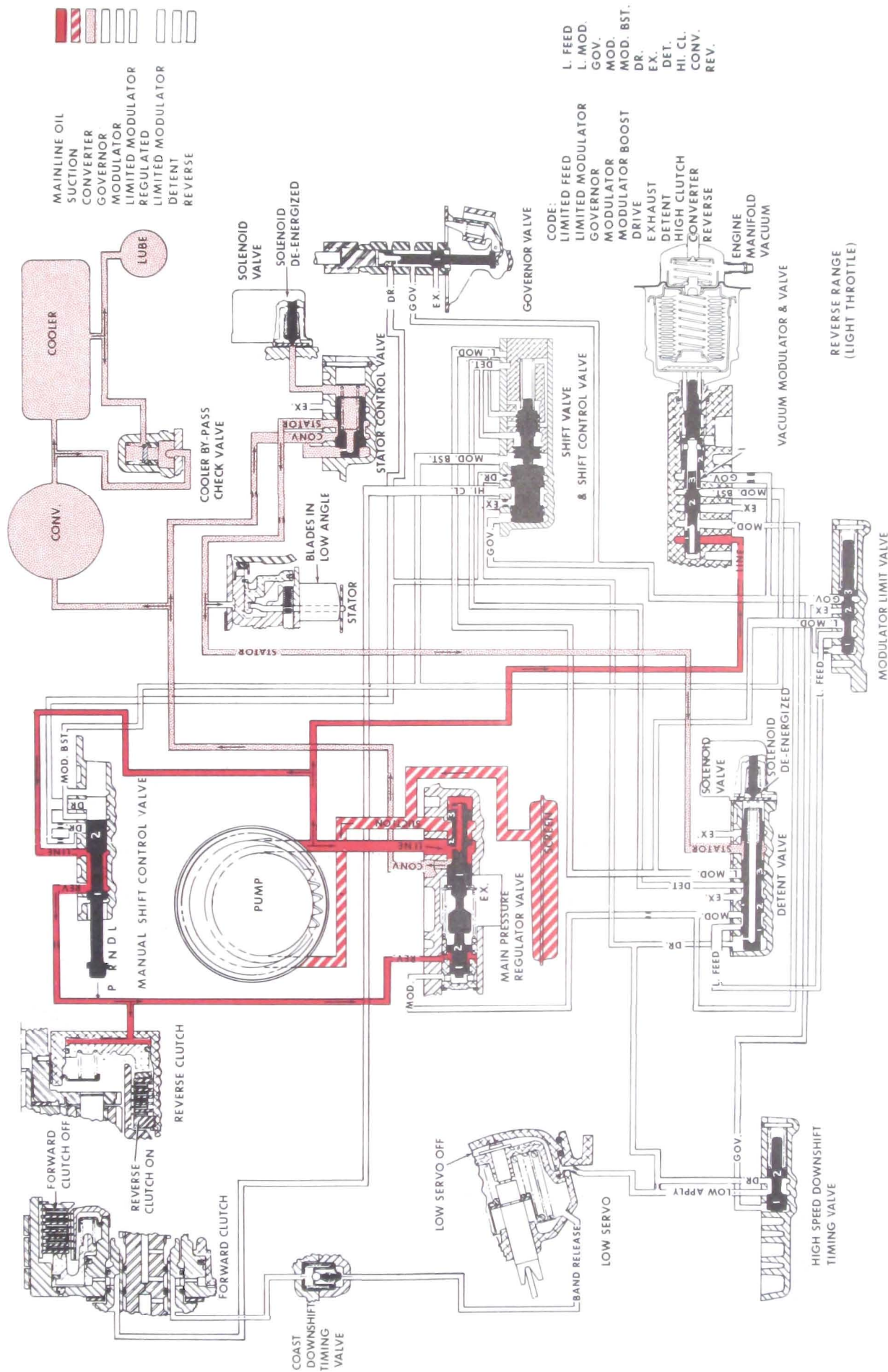

Figure 5-36—Reverse Range (Light Throttle)

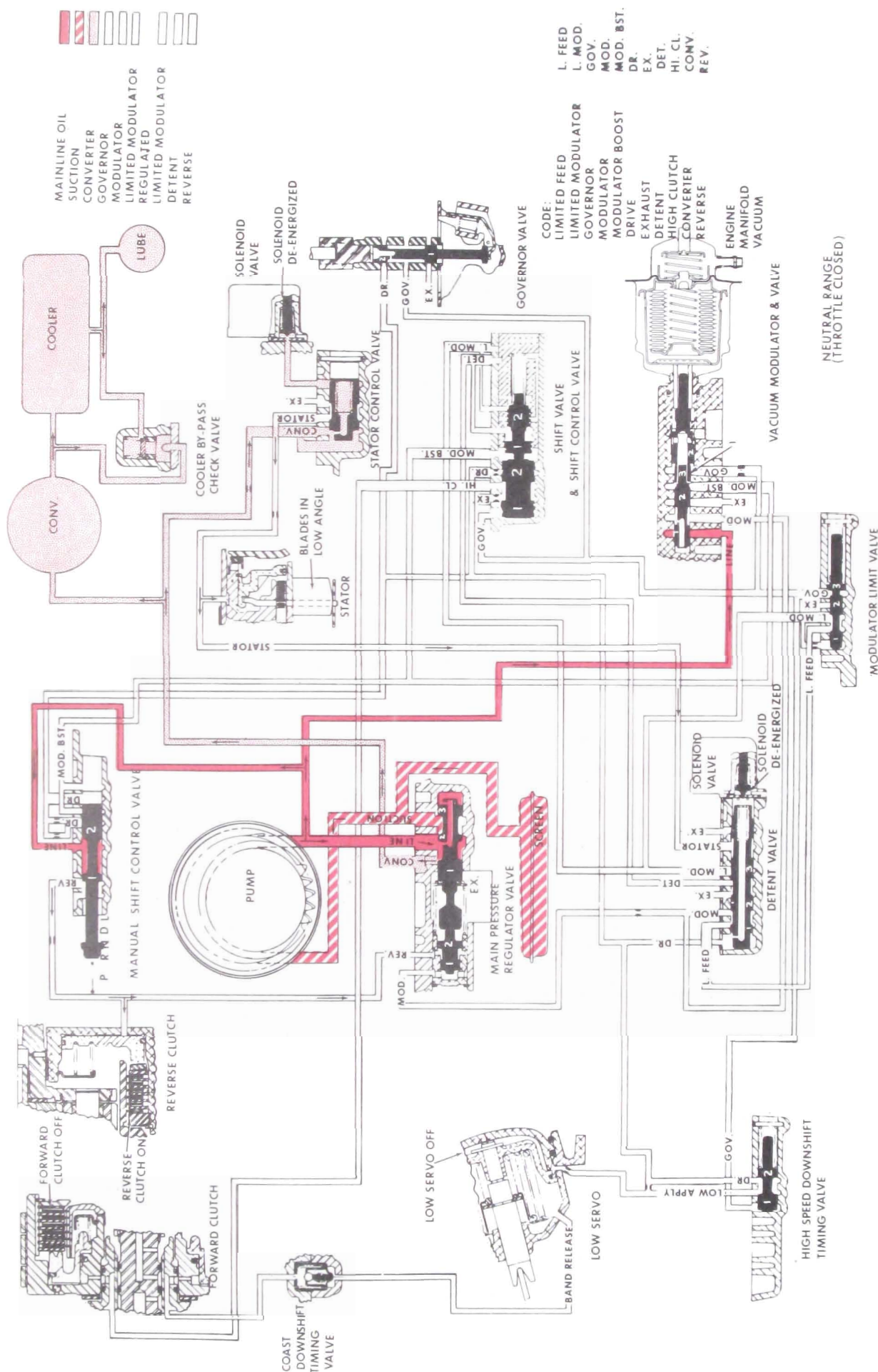

Figure 5-37—Neutral Range (Throttle Closed)



of the valve keeping it at the bottom of its bore as long as the solenoid is energized.

Energization of the detent solenoid allows oil from the center of the valve to flow to exhaust. Drive oil applying force to the area between the valve body and the first land of the valve moves the valve against its spring pressure to the bottom of its bore.

During a full-throttle acceleration main line oil is directed to the modulator valve and manual shift control valve. Main line oil entering the manual shift control valve is routed into the drive oil passage and then directed to the governor valve, shift valve, detent valve, high speed down shift timing valve, and modulator limit valve, and low servo.

Main line oil directed to the modulator valve enters between the first and second lands. At low engine vacuum the vacuum modulator tends to keep the valve toward the bottom of its bore. In this position oil is delivered through a drilled passage in the valve to the space between the first land of the valve and the valve body. Oil pressure in this area plus governor pressure on the second land of the second modulator valve tend to move the valve against the force of its spring to regulate oil pressure leaving the valve.

Modulator pressure applies force to the left end of the boost valve causing it to move to the right. As the boost valve moves to the right it contacts the pressure regulator valve. This hydraulic force combined with normal spring force on the pressure regulator valve results in a higher main line pressure. With the detent valve solenoid energized, drive oil pressure will enter into the limited feed line. When limited feed pressure reaches a high enough value and exerts enough

force to overcome spring pressure on the modulator limit valve, the valve will regulate governing the limited modulator and detent pressure behind the shift regulator valve.

As higher governor pressure is reached it acts on in the area between the valve body and the first land of the high speed down shift timing valve until governor pressure overcomes spring pressure and moves the valve to the right. This movement blocks the non-restricted line, routing the servo apply oil through the restricted orifice. On a down shift this restriction of flow causes the band apply to be delayed slightly and is thus timed to the forward clutch release for a smooth down shift.

#### **m. Operation of Hydraulic Controls in Low Range (Closed Throttle Coast)**

During operation in Low range, the manual shift control valve is positioned as shown in Figure 5-35. During a closed throttle coast in low range, main line oil is directed to the modulator valve and manual shift control valve. Main line oil entering the manual shift control valve is routed into drive oil passage and modulator boost passage. Oil routed in the drive oil passage is directed to the governor valve, shift valve, and detent valve, high speed down shift timing valve and low servo. Oil routed in the modulator boost passage is directed to the shift valve and vacuum modulator valve.

Modulator boost oil enters the shift valve between the shift valve and the shift control valve, moving the shift valve to the left and holding it in the bottom of its bore thus exhausting the forward clutch. Drive oil directed from the manual shift control valve will apply the low servo.

#### **n. Operation of Hydraulic Controls in Reverse Range (Light Throttle)**

During operation in Reverse range the manual shift control valve is positioned as shown in Figure 5-36. During light throttle in reverse, main line oil is directed to the manual shift control valve. Main line oil entering the manual shift control valve is directed to the reverse clutch and between the 1st and 2nd land of the boost valve. Main line pressure applies a force to the 2nd land of the boost valve causing it to move to the right. As the boost valve moves to the right it contacts the pressure regulator valve. This hydraulic force combined with normal spring force on the pressure regulator valve results in a higher main line pressure needed for reverse operation. When the manual shift control valve is in reverse the forward clutch and low servo are exhausted.

#### **o. Operation of Hydraulic Controls in Neutral Range (Closed Throttle)**

During operation in Neutral range, the manual shift control valve is positioned as shown in Figure 5-37. In neutral operation main line oil entering the manual shift control valve is routed to the vacuum modulator only. In neutral operation the stator control solenoid is energized switching the pitch to high angle.

NOTE: At any closed throttle condition a switch on the carburetor will energize the stator control solenoid switching the pitch to high angle. By switching the pitch to high angle it will allow higher engine RPM in relation to turbine speed. With the solenoid energized the valve will bottom in its bore allowing the stator to exhaust switching the pitch to high angle.

## 5-7 TRANSMISSION ASSEMBLY—REMOVAL AND INSTALLATION

### a. Removal

1. Raise car and provide support for front and rear of car.
2. Disconnect front exhaust pipe bolts at the exhaust manifold and at the connection of the intermediate exhaust pipe location (single exhaust only). On dual exhaust the exhaust pipes need not be removed.
3. Remove pinion flange "U" bolts and slide propeller shaft toward transmission as far as possible to separate universal joint from pinion flange. Remove propeller shaft from car.
4. Place suitable jack under transmission and fasten transmission securely to jack.
5. Remove vacuum line to vacuum modulator hose from vacuum modulator.
6. Loosen cooler line nuts and separate cooler lines from transmission.
7. Remove transmission mounting pad to cross member bolts.
8. Remove transmission cross member support to frame rail bolts. Remove cross member.

9. Disconnect speedometer cable.
10. Loosen shift linkage adjusting swivel clamp nut. Remove cotter key, spring, and washer attaching equalizer to outer range selector lever. Remove equalizer.
11. Disconnect transmission filler pipe at engine. Remove filler pipe from transmission.
12. Support engine at oil pan.
13. Remove transmission flywheel cover pan to case tapping screws. Remove flywheel cover pan.
14. Mark flywheel and converter pump for reassembly in same position, and remove three converter pump to flywheel bolts.
15. Remove transmission case to engine block bolts.

**CAUTION:** Install Tool J-21366 to retain converter.

16. Move transmission rearward to provide clearance between converter pump and crankshaft. Lower transmission and move to bench.

### b. Installation

1. Assemble transmission to suitable transmission jack and raise transmission into position. Rotate converter to permit coupling of flywheel and converter with original relationship.

2. Install transmission case to engine block bolts. Torque to 30-40 ft. lbs. Do not overtighten.
3. Install flywheel to converter pump bolts. Torque to 30-40 ft. lbs.
4. Install transmission cross member support. Install mounting pad to cross member.
5. Remove transmission jack and engine support.
6. Install transmission flywheel cover pan with tapping screws.
7. Install transmission filler pipe using a new "O" ring.
8. Reconnect speedometer cable.
9. Install propeller shaft. Connect propeller shaft to pinion flange.
10. Reinstall front exhaust crossover pipe.
11. Install oil cooler lines to transmission.
12. Install vacuum line to vacuum modulator.
13. Fill transmission with oil as follows:
  - a. Add 4 pints of oil.
  - b. Start engine in neutral. **DO NOT RACE ENGINE.** Move manual control lever through each range.
  - c. Check oil level, adjust oil level to full mark on dipstick, only when oil is hot.

5-8 ADJUSTMENT ON CAR

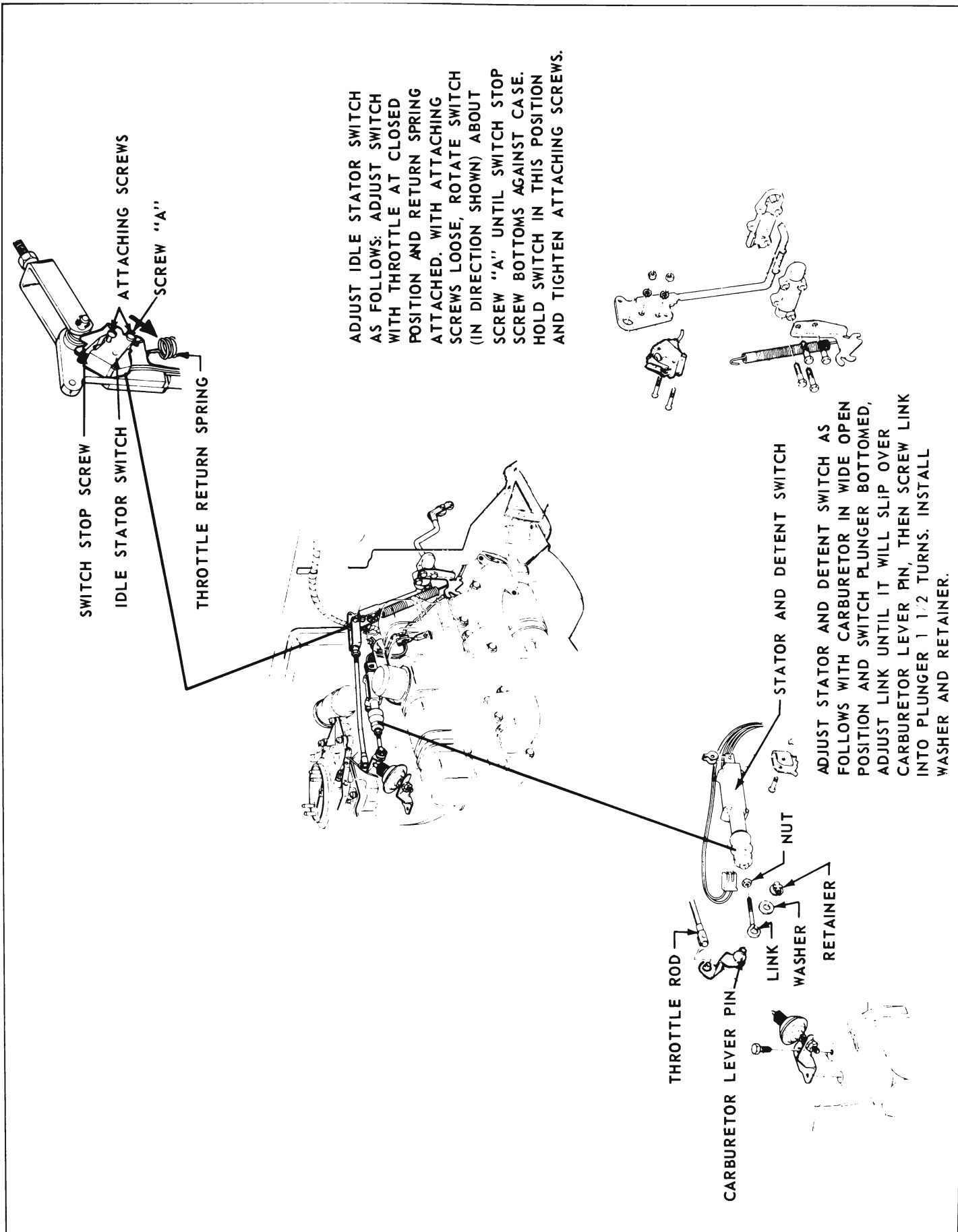

Figure 5-38—Transmission Control Switch Adjustments