

SECTION 11-D
REMOTE CONTROL OUTSIDE MIRROR, REAR WINDOW DEFROSTER,
VACUUM TRUNK RELEASE, FOUR NOTE
HORN AND TACHOMETER INSTALLATIONS

CONTENTS OF SECTION 11-D

Paragraph	Subject	Page
11-21	Servicing Accessories . . . ,	11-81

11-21 SERVICING ACCESSORIES

The following accessories pictured herein are provided as optional equipment on 1964 Buick 4000, 4100 and 4300 Series cars. The servicing, such as removal and installation, of the accessory components will be obvious when viewing the installation illustrations contained on the following pages.

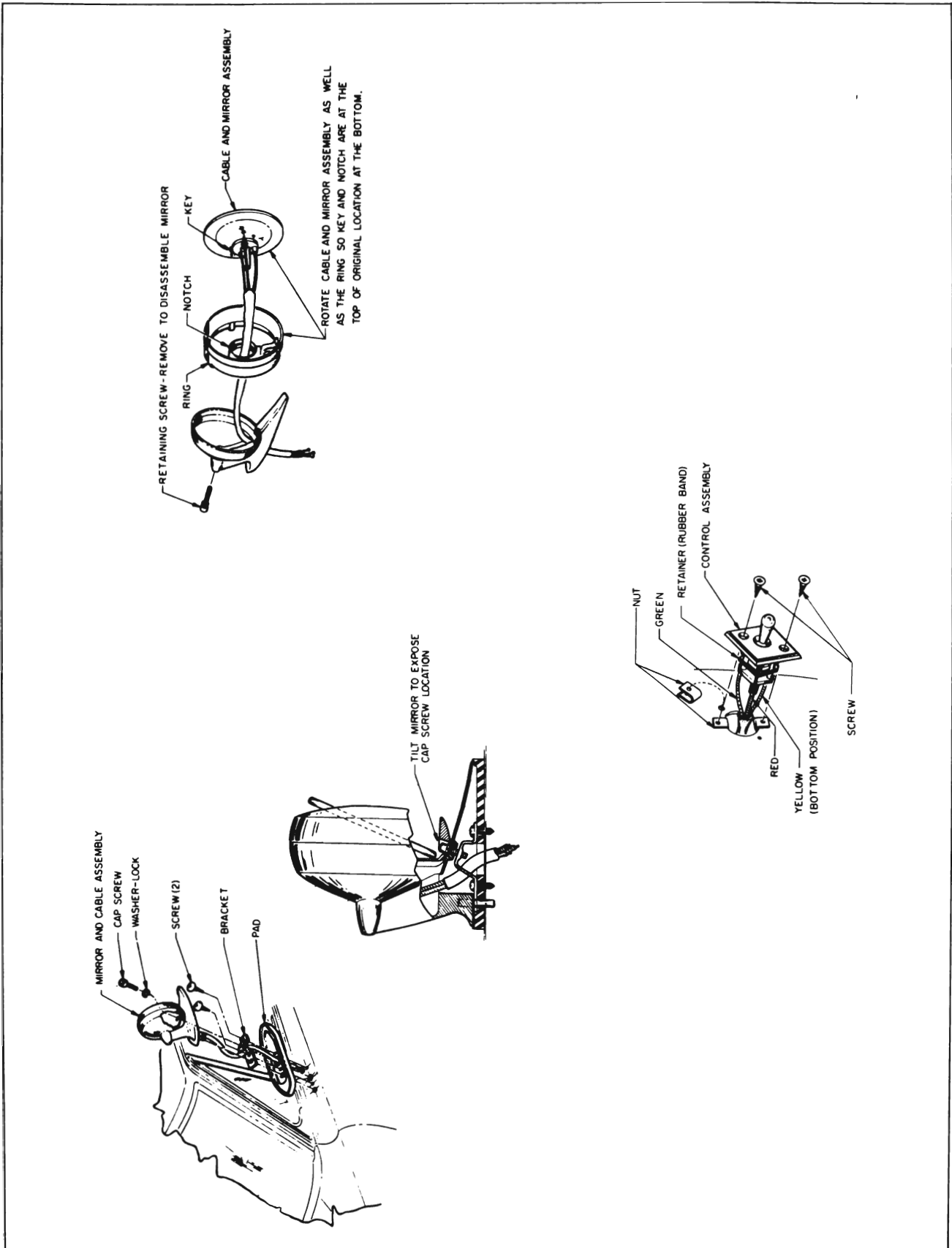

Figure 11-120—Remote Control Outside Mirror Installation

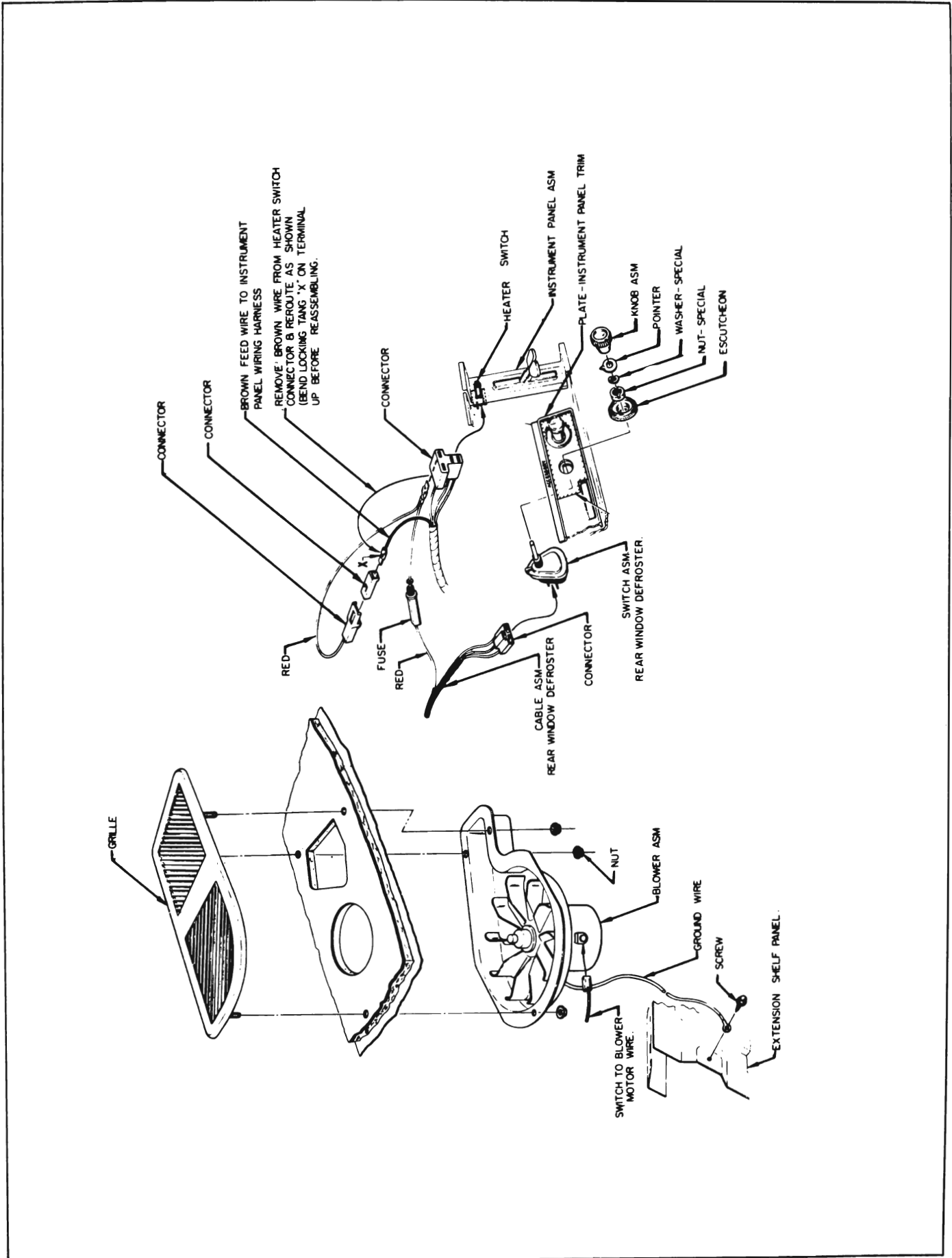

Figure 11-121—Rear Window Defroster Blower and Switch Installation

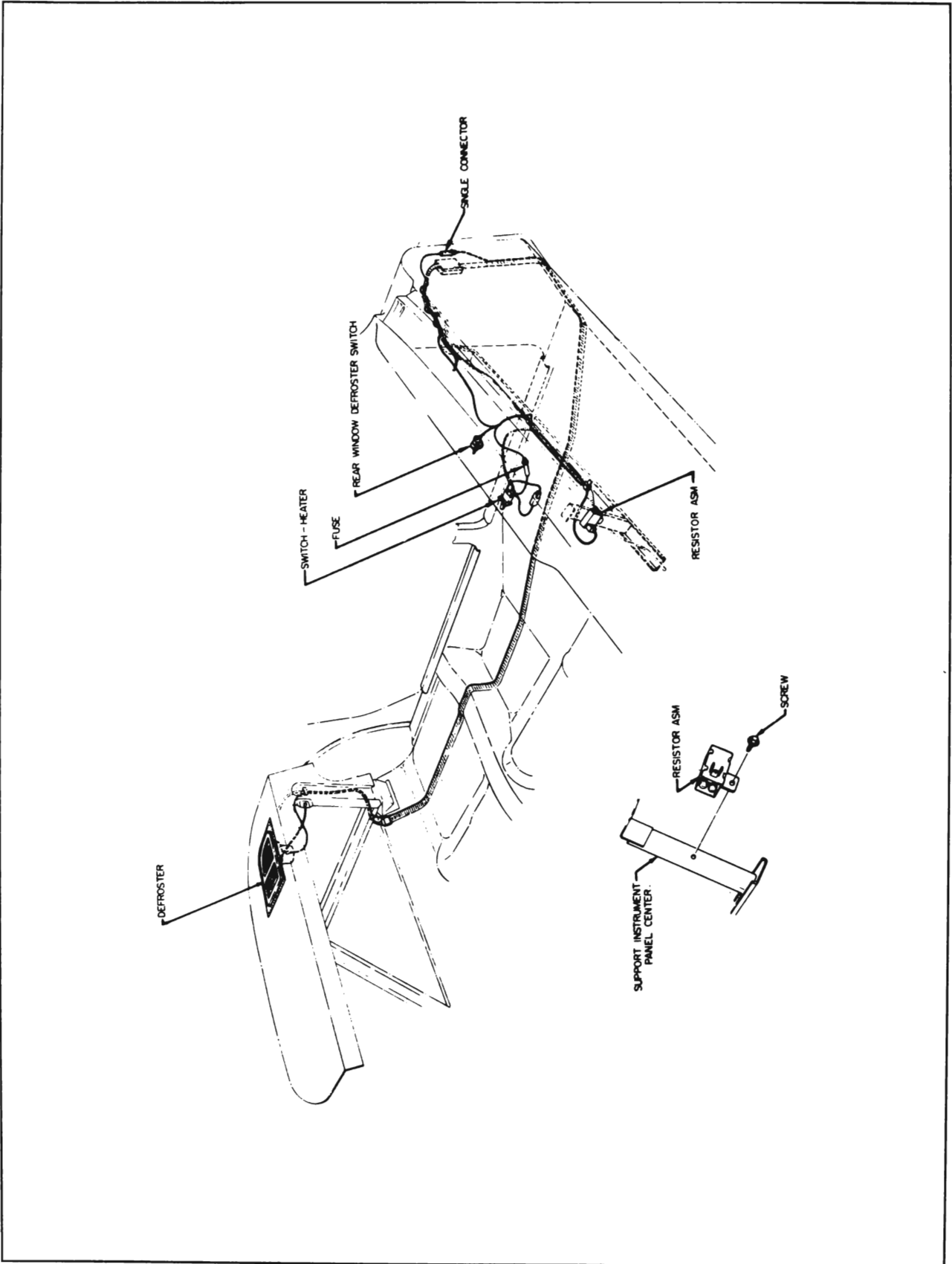

Figure 11-122—Rear Window Defroster Wiring Installation

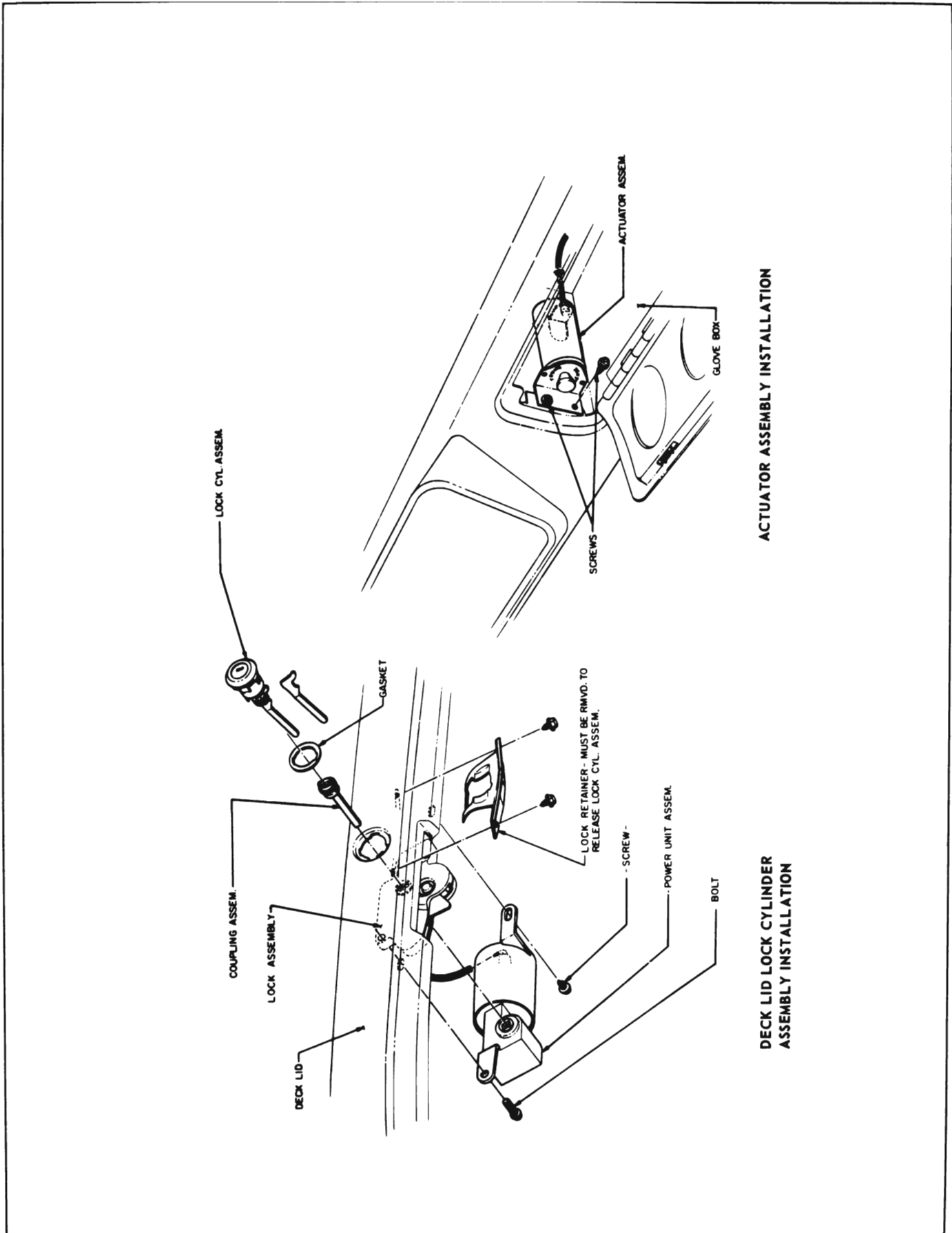

Figure 11-123—Vacuum Trunk Release Power Unit and Actuator Installation

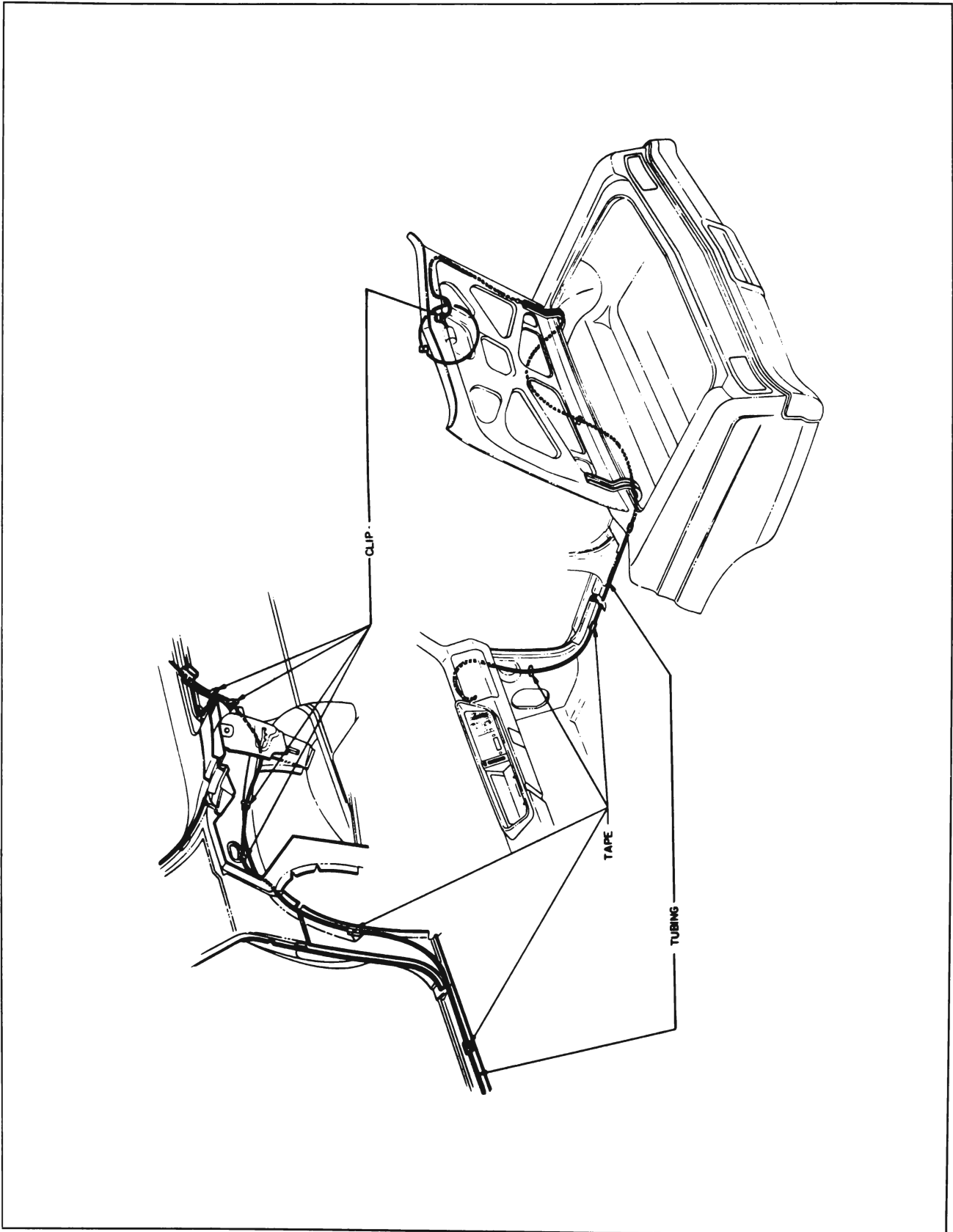

Figure 11-124—Vacuum Trunk Release Tubing Installation

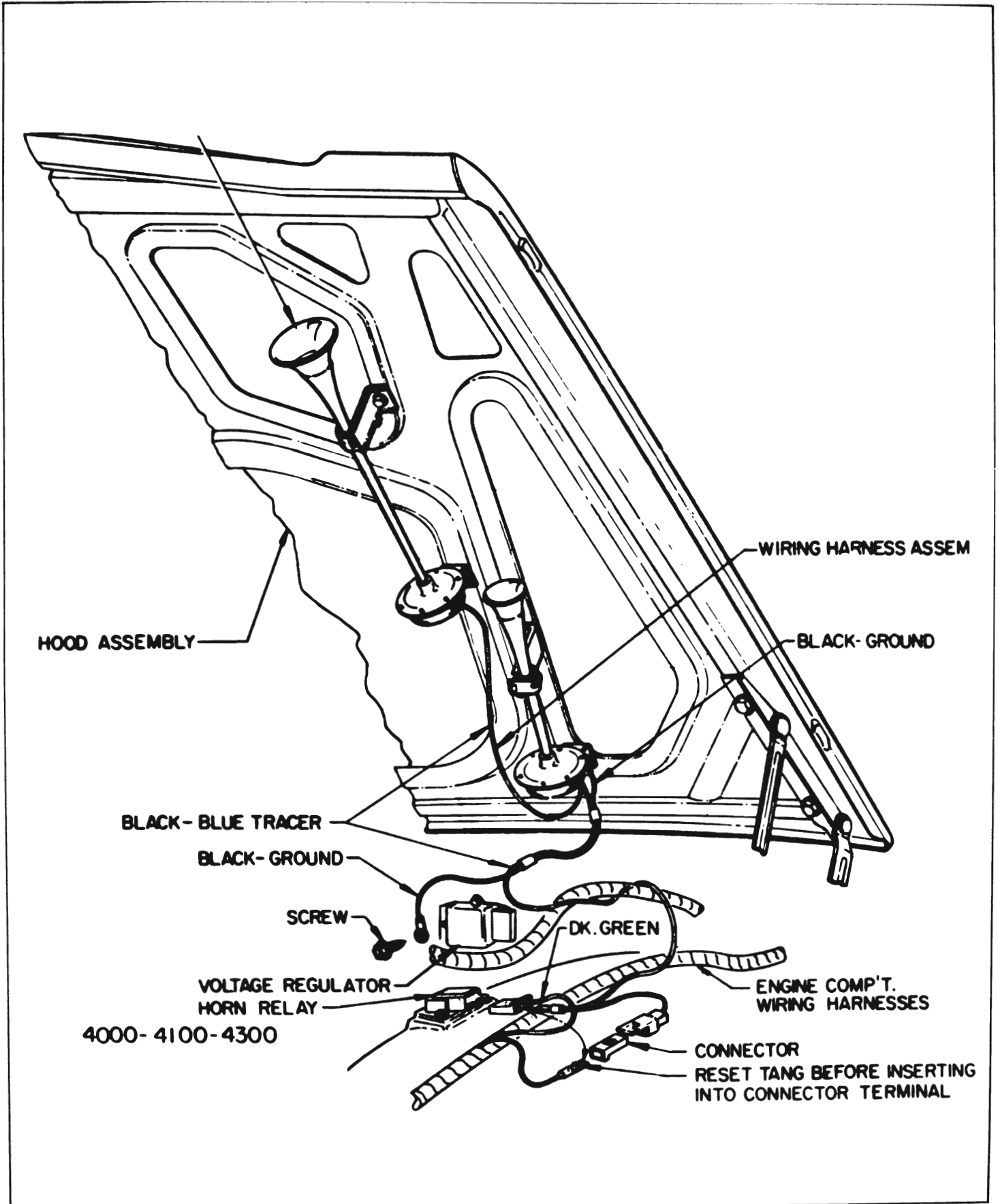

Figure 11-125—Four Note Horn Installation

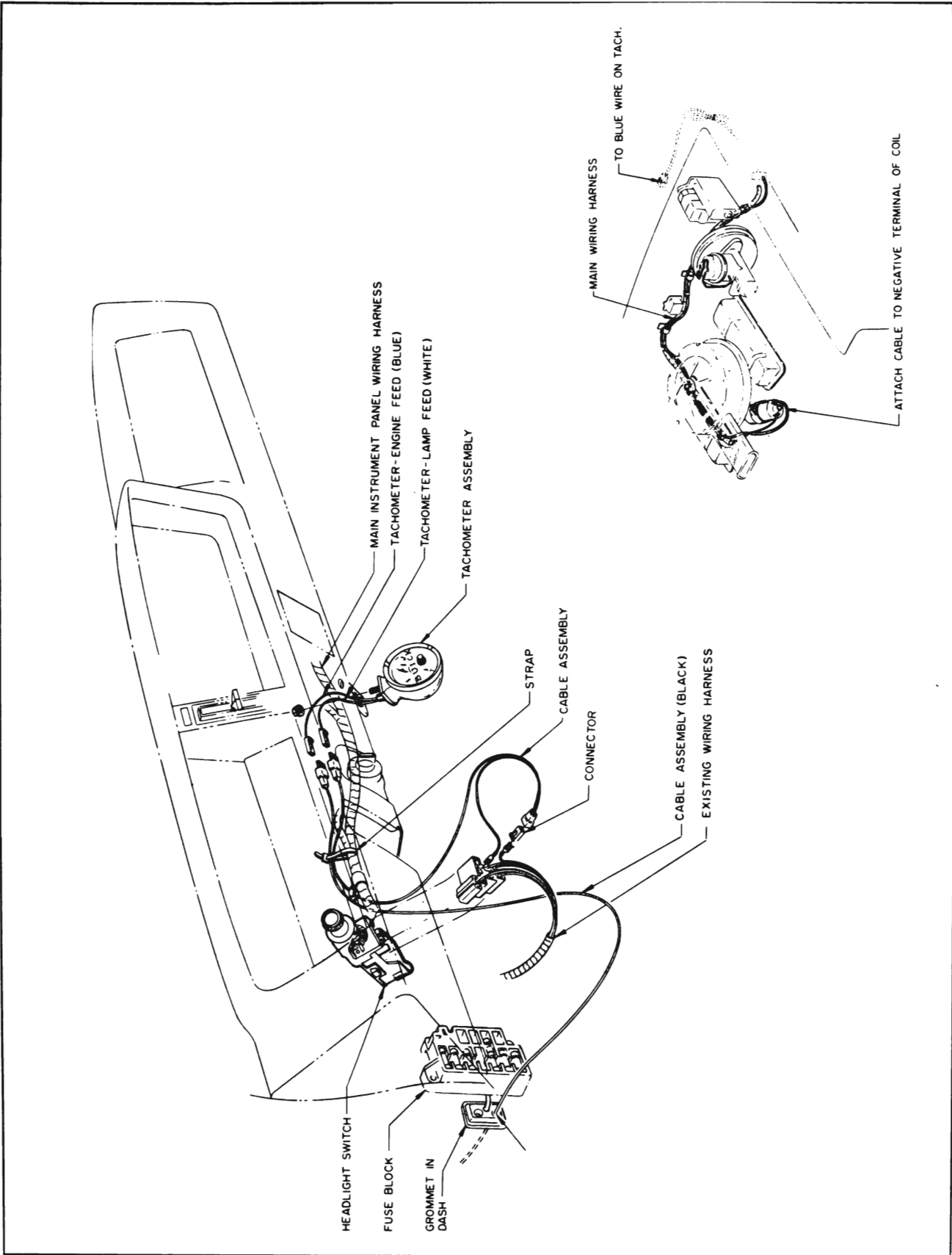

Figure 11-126—Tachometer Installation