

SECTION 10-D

CRANKING (STARTER) SYSTEM

CONTENTS OF SECTION 10-D

Paragraph	Subject	Page	Paragraph	Subject	Page
10-23	Description of Cranking System . .	10-23	10-28	Voltage Test of Cranking System and Solenoid System . . .	10-28
10-24	Operation of Cranking System. . . .	10-23	10-29	Amperage Test of Solenoid and Pinion Clearance Check.	10-29
10-25	Cranking Motor and Solenoid Switch	10-26	10-30	Bench Test of Cranking Motor . . .	10-30
10-26	Trouble-Shooting Cranking System	10-26	10-31	Cranking Motor Repairs - on Bench	10-30
10-27	Periodic Inspection of Cranking Motor	10-28			

10-23 DESCRIPTION OF CRANKING SYSTEM

In the Buick cranking system, the engine is cranked by turning the ignition switch to the extreme clockwise position marked "START". The "START" position is spring loaded in such a way that the switch returns to the "ON" position when released.

The cranking system, shown schematically in Figure 10-24, is composed of the following units:

1. Battery and battery cables (par. 10-11).
2. Cranking motor, including the drive assembly which engages the flywheel ring gear during cranking operation (par. 10-25).
3. Cranking motor solenoid switch, mounted on the cranking motor, for shifting the drive assembly and closing the motor circuit (par. 10-25).
4. Ignition switch, which when in the "START" position connects a lead from the battery to the solenoid switch, passing through the neutral safety switch on the way. During cranking the ignition switch also connects the battery directly to the ignition coil, thereby by-passing the resistance wire which normally supplies the ignition coil at a lower voltage.
5. Neutral safety switch (auto-

matic transmission cars only). This switch is connected between the ignition switch and the solenoid switch to prevent cranking of the engine except when the transmission control lever is in either neutral (N) or park (P) position.

10-24 OPERATION OF CRANKING SYSTEM

When the ignition switch is turned fully clockwise to the "START" position, a connection is made from the battery terminal of the ignition switch to the solenoid terminal of the switch. From here, a large wire carries the current to a terminal on the solenoid switch of the cranking motor. A neutral safety switch is located in series in this wire. The transmission control lever must be in neutral (N) or park (P) position so that the neutral safety switch is also closed.

Closing of the ignition "START" switch and the neutral safety switch permits battery current to flow through the "pull-in" and "hold-in" coils of the solenoid, magnetizing the solenoid. The plunger is pulled into the solenoid so that it operates the shift lever to move the drive pinion into engagement with the flywheel ring gear. The solenoid switch contacts then close after the drive pinion is partially engaged with the ring gear; this prevents any

possible gear clash. See Figure 10-24.

The closing of the solenoid switch contacts causes the motor to crank the engine and also cuts out the "pull-in" coil of the solenoid, the magnetic pull of the "hold-in" being sufficient to hold the pinion in mesh after the shifting has been performed. This reduces the current consumed by the solenoid while the cranking motor is operating. See Figure 10-24.

As soon as the engine starts running, the overrunning clutch starts free-wheeling. This allows the starter pinion to be driven by the flywheel ring gear without causing the armature speed to increase greatly. (Because of the large gear ratio between the pinion and the ring gear, a seized overrunning clutch will cause the armature to be driven at an excessive speed which may cause the armature windings to be thrown). As soon as the driver realizes that the engine has started, he releases the ignition key and a spring in the ignition switch returns it to the "ON" position. This breaks the solenoid circuit so that the solenoid is demagnetized. A return spring then actuates the shift lever to retract the solenoid plunger, which permits another spring to open the solenoid switch contacts. The

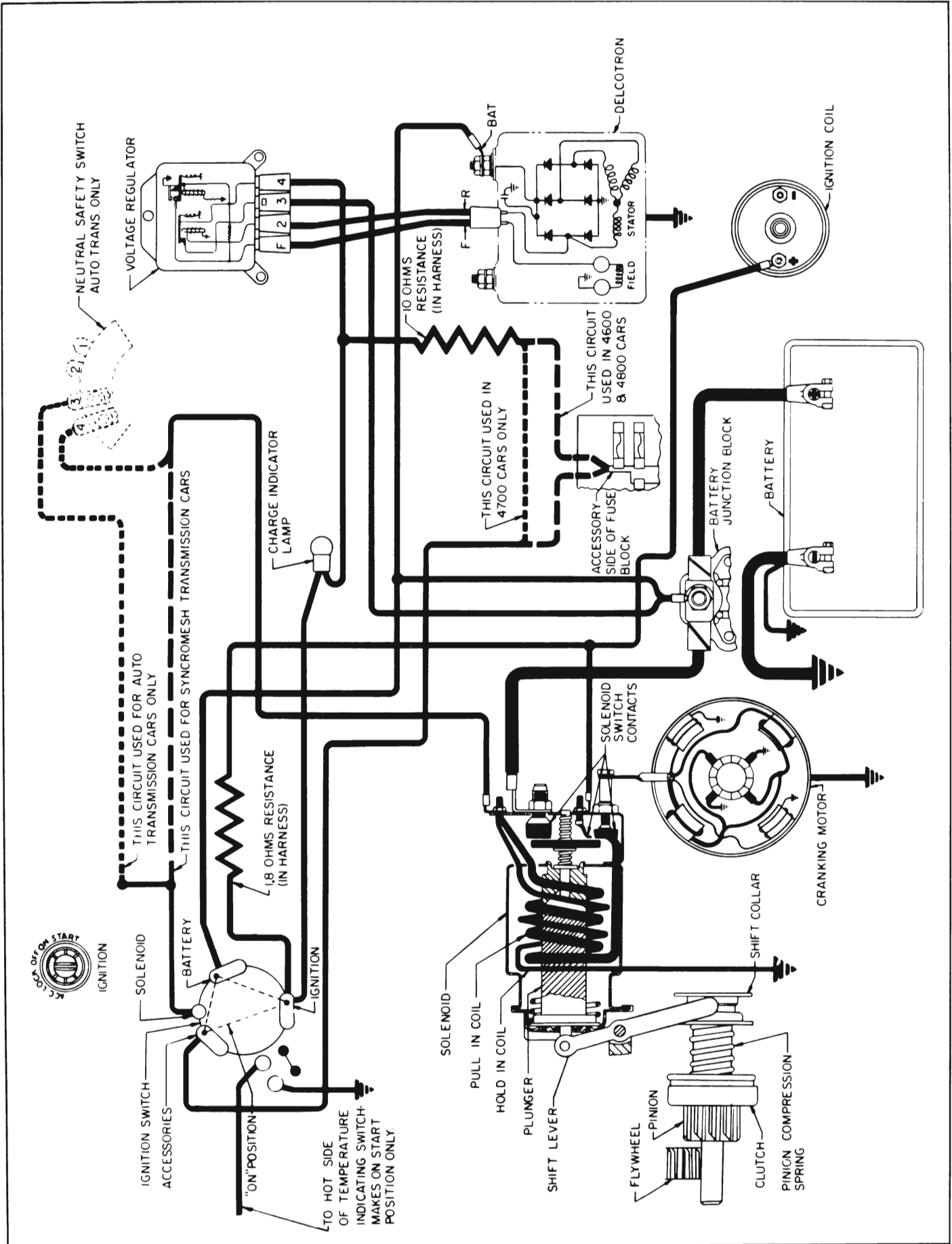

Figure 10-25—Starter and Generator Circuit Diagram -46-47-4800 Series

shift lever then disengages the drive pinion from the flywheel ring gear. After the transmission is shifted out of park or neutral, the neutral safety switch will prevent accidental engagement of the drive pinion with the flywheel.

10-25 CRANKING MOTOR AND SOLENOID SWITCH

The cranking motor assembly consists of a motor, drive assembly, shift lever, and solenoid switch. See Figure 10-26.

a. Cranking Motor, Drive and Shift Lever

The cranking motor is an enclosed shift lever type, having an extruded frame, four poles and a compound field. The drive end housing is extended to enclose the entire shift lever mechanism and plunger to protect them from road dirt, icing conditions, and splash. The solenoid is flange mounted onto the drive end housing and is sealed to the drive housing by a sealing compound. The shift lever return spring is a compression type and is located inside the solenoid case. A rubber grommet assembled in the frame around the field lead insulates it from grounding and also prevents dirt, water, and oil from entering the motor.

The armature shaft is supported at both ends in graphite bronze bushings pressed into the commutator end frame and the drive housing. Neither of these bearings require lubrication except during assembly. See Figure 10-26.

The four brushes are supported by brush holders mounted on the field frame. Two opposing

brushes are connected to the field coils. The field coils are held in place by the pole shoes which are attached to the field by large screws. The field coils are connected to an insulated connecting link in the field frame, through which current is supplied to the motor.

The drive assembly is mounted on the motor armature shaft and keyed to it by helical splines so that it can be moved endwise on the shaft by the solenoid operated shift lever. It transmits cranking torque to the flywheel ring gear, but its overruning clutch allows the drive pinion to rotate freely with reference to the armature shaft when the engine begins to operate, thus preventing the armature from being driven at excessive speed by the engine.

The drive assembly pinion is moved into engagement with flywheel ring gear by action of the solenoid upon the shift lever, which engages the shift collar of drive assembly. The shift collar moves the drive assembly by pushing on the clutch spring, which serves as a cushion in case the pinion and gear teeth butt instead of meshing. The helical splines assist in obtaining proper pinion engagement. The drive pinion is pulled out of engagement, after engine starts, by action of the shift lever return spring. The shift lever is connected to the solenoid switch plunger by a roll pin. See Figure 10-26.

The high torque cranking motor has two parallel field coils connected to the insulated brushes, and two shunt field coils connected to ground. The purpose of this design is to increase starting torque. Heavier field and armature windings help accomplish this. The additional shunt field is required to control free speed of the motor. See Figure 10-27.

b. Solenoid Switch

The solenoid switch not only closes the circuit between the battery and the cranking motor to produce cranking action, but it also operates the shift lever to move the drive pinion into engagement with the flywheel ring gear.

The solenoid section of the switch has a plunger and two windings, the "pull-in" winding and the "hold-in" winding. Together, they provide sufficient magnetic attraction to pull the solenoid plunger into the solenoid. The plunger actuates the shift lever and drive assembly and it also closes the solenoid switch contacts by pressing against a push rod upon which a contact disk is mounted between two coil springs. One spring serves as a cushion to insure firm contact of the disk with two stationary contacts. The other spring pushes the disk away from the stationary contacts to break the circuit when the solenoid is demagnetized after the engine starts. One stationary contact is connected to the battery positive cable and the other is connected to the motor windings through a connector or bus bar. See Figure 10-26.

Operation of solenoid switch, as well as the entire cranking system, is described in paragraph 10-23.

10-26 TROUBLE-SHOOTING CRANKING SYSTEM

a. No Cranking Action

1. Make sure that control lever is in neutral (N) or park (P) position.

2. Make quick check of battery and cables (par. 10-11). If battery is low, the solenoid usually will produce a clattering noise, because a nearly discharged battery

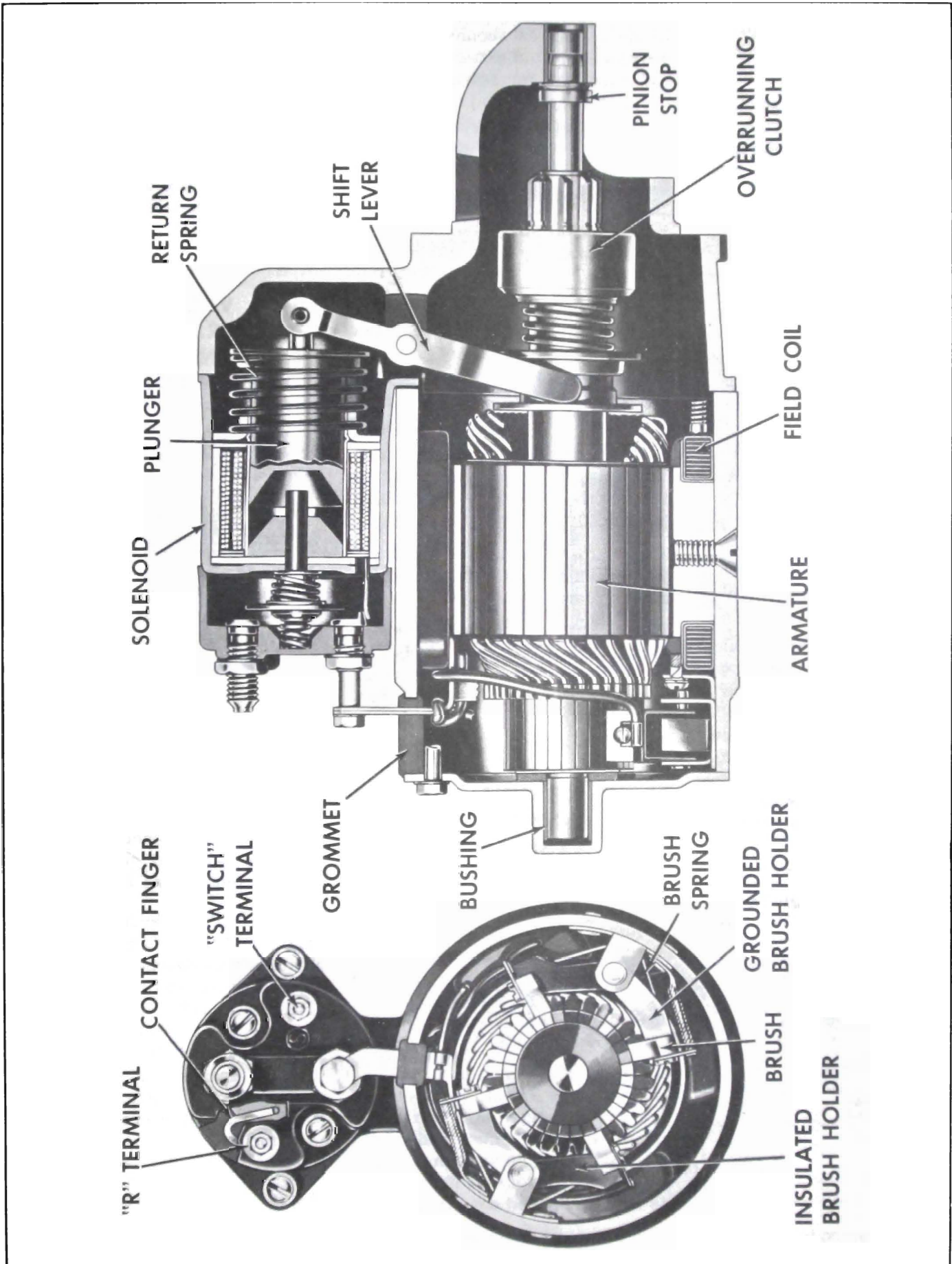

Figure 10-26—Cranking Motor

will not sustain the voltage required to hold solenoid plunger in after solenoid switch has been closed.

3. If cranking motor spins and drive pinion engages ring gear but does not drive it, overrunning clutch is slipping. Remove motor to replace drive assembly.

4. If cranking motor does not operate, note whether solenoid plunger is pulled into solenoid when solenoid circuit is closed. Ordinarily the plunger makes a loud click when it is pulled in. If plunger is pulled in, solenoid circuit is okay and trouble is in solenoid switch, cranking motor, or cranking motor circuit. The cranking motor must be removed for repairs to switch or motor (par. 10-30).

5. If plunger does not pull into solenoid when ignition switch is turned to "START", the solenoid circuit is open, or solenoid is at fault.

6. To find reason why plunger does not pull into solenoid, disconnect purple solenoid wire at connector near battery terminal block and press wire end against post of terminal block. If cranking motor operates, solenoid is okay; trouble is in ignition switch, neutral safety switch, or in wires and

connections between these units.

7. As a final test, connect jumper between solenoid battery terminal and terminal on solenoid switch to which purple wire is connected. If cranking motor still does not operate, remove motor for inspection and test of solenoid switch (par. 10-29).

b. Cranking Speed Abnormally Low

Abnormally low cranking speed may be caused by low battery or defective cables, defective solenoid switch, defective cranking motor, or an internal condition of engine.

1. Make quick check of battery. If low battery is indicated, test battery (par. 10-9). If defective cables are indicated, test cables (par. 10-11).

2. If battery and cables are okay, test cranking motor and solenoid switch (par. 10-28).

3. If cranking motor and solenoid switch test okay, the trouble is due to an internal condition of engine. This may be due to use of engine oil which is too heavy for prevailing temperatures.

10-27 PERIODIC INSPECTION OF CRANKING MOTOR

No periodic lubrication of the cranking motor or solenoid is required. The cranking motor and brushes cannot be inspected without disassembling the unit so no service is required on the cranking motor and solenoid between inspection periods.

Cranking motor action is indicative, to some extent, of the cranking motor condition. A cranking motor that responds readily and cranks the engine at normal speed when the control circuit is closed is usually in good condition.

Check motor and solenoid switch attaching bolts to make sure these

units are solidly mounted. Inspect and manually check all wiring connections at solenoid switch, ignition switch, and neutral safety switch. Make sure that all these connections in the cranking motor and control circuits are clean and tight. It is advisable to test the cranking circuit to make certain that excessive resistance does not exist. See paragraph 10-28.

10-28 VOLTAGE TEST OF CRANKING SYSTEM AND SOLENOID SWITCH

The voltage across the cranking motor and switch while cranking the engine gives a good indication of any excessive resistance. NOTE: Engine must be at normal operating temperature when test is made.

1. Inspect battery and cables (par. 10-11) to make certain that battery has ample capacity for cranking and ignition.

2. Connect jumper wire to distributor terminal of coil and to ground on engine, so that engine can be cranked without firing.

3. Connect voltmeter positive (+) lead to the motor terminal on solenoid switch; connect voltmeter negative (-) lead to ground on starter. See Figure 10-28.

4. Turn ignition switch on, crank engine and take voltmeter reading as quickly as possible. If cranking motor turns engine at normal cranking speed with voltmeter reading 9 or more volts, the motor and switch are satisfactory. If cranking speed is below normal and voltmeter reading is 9 or greater, the cranking motor is defective.

CAUTION: Do not operate cranking motor more than 30 seconds at a time without pausing to allow motor to cool for at least two minutes; otherwise, overheating

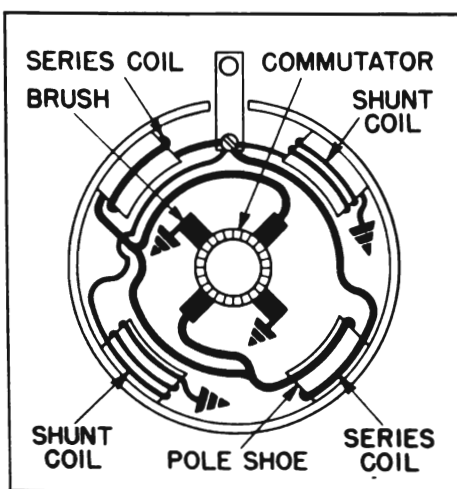

Figure 10-27—Cranking Motor Circuits—401 and 425 Engines

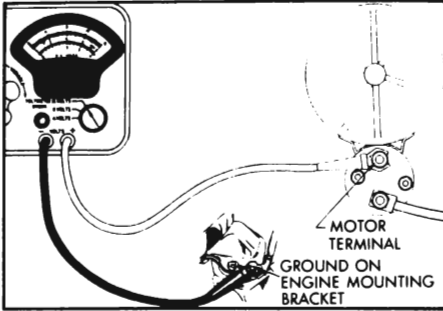

Figure 10-28—Cranking Voltage Test Connections

and damage to motor may result.

5. If cranking motor turns engine at low rate of speed with voltmeter reading less than 9 volts, test solenoid switch contacts as follows:

6. With voltmeter switch turned to any scale above 12 volts, connect voltmeter negative (-) lead to the motor terminal of solenoid switch, and connect positive (+) lead to battery terminal of switch. See Figure 10-29.

7. Turn ignition switch on and crank engine. Immediately turn voltmeter switch to low scale and take reading as quickly as possible, then turn switch back to higher scale and stop engine.

The voltmeter will read not more than 1/10 volt if switch contacts are satisfactory. If voltmeter reads more than 1/10 volt, switch should be repaired or replaced.

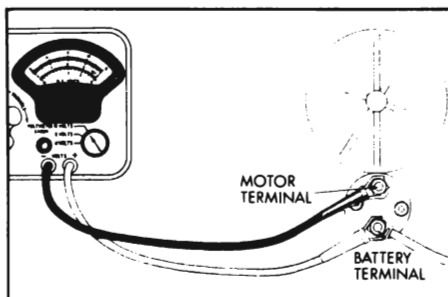

Figure 10-29—Solenoid Switch Contact Test Connections

10-29 AMPERAGE TEST OF SOLENOID AND PINION CLEARANCE CHECK

a. Testing Solenoid Switch Windings

- (1) Current draw of both windings in parallel.
- (2) Current draw of hold-in winding alone.

1. Remove screw from solenoid motor terminal and bend field leads slightly until clear of terminal. Then ground solenoid motor terminal with a heavy jumper wire. See Figure 10-30.

2. Connect a 12-volt battery, a variable resistance, and an ammeter of 100 amperes capacity in series with solenoid "S" terminal. Connect a heavy jumper wire from solenoid base to ground post of battery.

3. Connect a voltmeter between base of solenoid and small solenoid "S" terminal.

4. Slowly adjust resistance until voltmeter reads 10 volts and note ammeter reading. This shows current draw of both windings in parallel, and should be 41 to 47 amperes (large starter) or 42 to 49 amperes (small starter). See Figures 10-24 and 25 for diagrams of solenoid circuits.

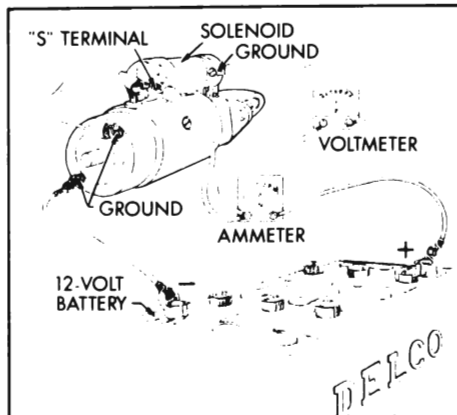

Figure 10-30—Amperage Test of Solenoid

5. Remove jumper wire from solenoid motor terminal and re-adjust resistance until voltmeter reads 10 volts, then note ammeter reading. This shows current draw of hold-in winding alone, and should be 14.5 to 16.5 amperes (large starter) or 10.5 to 12.5 amperes (small starter), with solenoid at room temperature.

6. If solenoid windings do not test within specifications given, solenoid switch assembly should be replaced.

b. Checking Pinion Clearance

Whenever the cranking motor is disassembled and reassembled, the pinion clearance should be checked. This is to make sure that proper clearance exists between the pinion and pinion stop retainer when pinion is in cranking position. Lack of clearance would prevent solenoid starter switch from closing properly; too much clearance would cause improper pinion engagement in ring gear.

1. Connect a source of approximately 6 volts (3 battery cells or a 6 volt battery) between the solenoid "S" terminal and ground. CAUTION: Do not use more than 6 volts or the motor will operate. As a further precaution to prevent motoring, connect a heavy jumper wire from the solenoid motor terminal to ground.

2. After energizing the solenoid, push the pinion away from the stop retainer as far as possible and use feeler gauge to check clearance between pinion and retainer. See Figure 10-31.

3. If clearance is not between .010" and .140", it indicates excessive wear of solenoid linkage, shift lever mechanism, or improper assembly of these parts. NOTE: Pinion clearance cannot be adjusted. If clearance is not correct, motor must be disassembled and checked for the above mentioned defects. Any defective parts must be replaced.

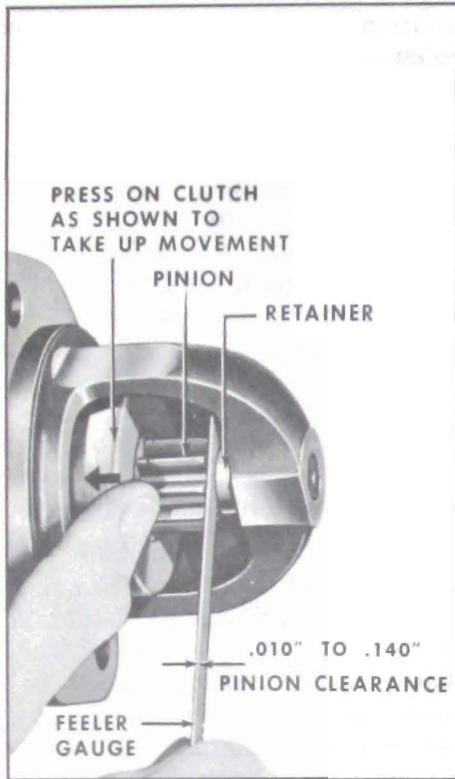

Figure 10-31—Checking Pinion Clearance

10-30 BENCH TEST OF CRANKING MOTOR

To obtain full performance data on a cranking motor, or to determine the cause of abnormal operation, the motor should be removed from the engine and be submitted to a no-load and a locked armature test with equipment designed for such tests. A high current carrying variable resistance should be connected into the circuit so that the specified voltage at the cranking motor may be obtained, since a small variation in the voltage will produce a marked difference in the current draw. Test specifications are given under Electrical Specifications in paragraph 10-3.

(a) No-load Test. Connect the cranking motor in series with a 12-volt battery and an ammeter capable of indicating several hundred amperes. If an RPM indicator is available, set it up to read armature RPM. Check current

draw and armature RPM at the specified voltage.

(b) Locked Armature Test. With the armature locked, check current draw at the specified voltage.

Rated current draw and no-load speed indicates normal condition of cranking motor. Abnormal conditions may be indicated by one of the following:

1. Low no-load speed and high current draw may result from:

(a) Tight, dirty, or worn bearings, bent armature shaft or loose field pole screws which would allow the armature to drag.

(b) Shorted armature. Check armature further on growler (par. 10-20).

(c) A grounded armature or field.

Check for grounds by raising the grounded brushes and insulating them from the commutator with cardboard. If the cranking motor has shunt field coils which are grounded to the field frame (see Figure 10-27), disconnect these fields from ground. Then check with a test lamp between the insulated terminal and the frame. If lamp lights, raise other brushes from commutator and check fields separately to determine whether it is the fields or armature that is grounded.

2. Failure to operate with high current draw may result from:

(a) a direct ground in the terminal or fields.

(b) Frozen shaft bearings which prevent the armature from turning.

3. Failure to operate with no current draw may result from:

(a) Open field circuit. Inspect internal connections and trace circuits with test lamp.

(b) Open armature coils. Inspect the commutator for badly burned bars.

(c) Broken or weakened brush

springs, worn brushes, high mica on the commutator, or other causes which would prevent good contact between the brushes and commutator. Any of these conditions will cause burned commutator bars.

4. Low no-load speed with low current draw indicates.

(a) An open field winding. Raise and insulate ungrounded brushes from commutator and check fields with test lamp. See Figure 10-27.

(b) High internal resistance due to poor connections, defective leads, dirty commutator and causes listed under item 3 (c).

5. High no-load speed with high current draw indicates shorted fields. There is no easy way to detect shorted fields, since the field resistance is already low. If shorted fields are suspected, replace the fields and check for improvement in performance.

10-31 CRANKING MOTOR REPAIRS—ON BENCH

a. Disassembly, Cleaning and Inspection

When it is necessary to disassemble cranking motor for any reason, make a complete clean-up and inspection to make sure all parts are in satisfactory condition. See Figure 10-26 for identification of parts.

1. Remove field lead connecting screw from motor terminal of solenoid.

2. Remove two thru bolts and remove commutator end frame and field frame assembly.

3. Pull out brush holder pivot pin and remove the two brush holders and the spring as a group. Remove screws attaching brushes and leads to holders.

4. Remove two screws holding solenoid to drive housing and remove solenoid. Remove small nut

and insulating washer from the solenoid "S" terminal. Remove large nut and insulating washer from the solenoid battery terminal. See Figure 10-26. Then, remove two screws that attach switch cover to solenoid and remove cover for inspection of switch parts.

5. Remove shift lever fulcrum bolt and remove shift lever, plunger and return spring.

6. Remove two screws holding center bushing plate to drive housing. Remove armature and drive assembly from drive housing. Remove thrust collar from pinion end of armature shaft.

7. To remove drive assembly from armature, place a metal cylinder of proper size (1/2" pipe coupling will do) over end of shaft to bear against the pinion stop retainer. Tap retainer toward armature to uncover snap ring. See Figure 10-32. Remove snap ring from groove in shaft, then slide retainer and pinion drive assembly from shaft.

8. Clean all parts by wiping with clean cloths. The armature, field coils, and drive assembly must not be cleaned by any degreasing

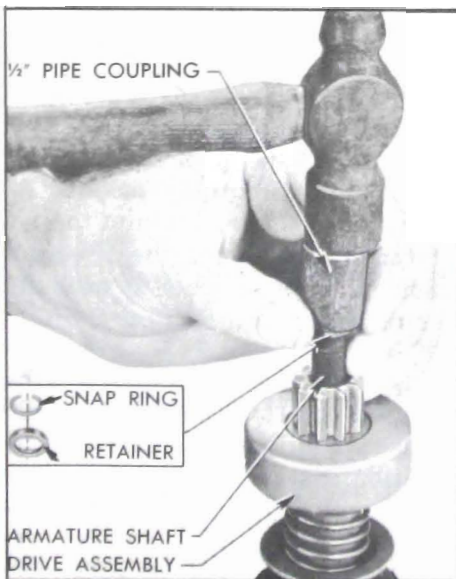

Figure 10-32—Removing Pinion Stop Retainer and Snap Ring

or high temperature method. This might damage insulation so that a short or ground would subsequently develop, and will remove lubricant originally packed in the overrunning clutch so that clutch would soon be ruined.

9. Carefully inspect all parts for wear or damage and make necessary repairs or replace unserviceable parts. Any soldering must be done with rosin flux; never use acid flux on electrical connections.

10. Test armature and make necessary repairs or turn commutator if required, following the same procedure as specified for generator in paragraph 10-20.

b. Assembly of Cranking Motor

1. Lubricate shift lever linkage and install in drive housing. **CAUTION:** Never lubricate solenoid plunger or plunger cylinder.

2. Assemble solenoid by reversing the disassembly procedure. Install return spring. Apply sealing compound on both sides of solenoid flange where it extends between drive housing and field frame. Then install solenoid.

3. Lubricate armature shaft with silicone grease. Install drive assembly with pinion outward.

4. Slide pinion stop retainer down over shaft with recessed side outward.

5. Place a new snap ring on drive end of shaft and hold it in place with a hard wood block. Strike block with hammer to force snap ring over end of shaft, then slide the ring down into groove in shaft. See Figure 10-33, View A.

6. Place thrust collar on shaft with shoulder next to snap ring, and move the retainer into contact with ring. Using pliers on opposite sides of shaft squeeze retainer and thrust collar together until snap ring is forced into the retainer. See Figure 10-33, View B.

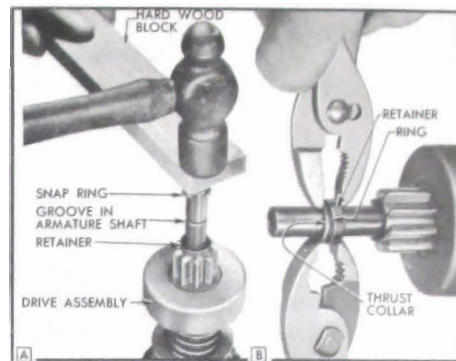

Figure 10-33—Pinion Stop Retainer and Snap Ring Installation

7. Lubricate drive housing bushing with silicone grease and install armature and drive assembly in housing.

8. Continue with assembly of cranking motor by reversing disassembly procedure. If field coils were removed from field frame, use care in tightening pole shoe screws to avoid distortion of parts and make sure that screws are securely tightened.

9. Position field frame assembly over armature assembly so that dowel pin engages hole in drive housing. Use care to prevent damage to brushes and brush holders. Make sure that brushes are properly seated on commutator.

10. Install thrust washer on commutator end of armature assembly. Lubricate bushing in commutator end frame with silicone grease and install end frame.

11. Install thru bolts and tighten securely. Connect field leads to motor terminal of solenoid with connecting screw.

12. Test solenoid switch and check pinion clearance as described in paragraph 10-29. If a reliable starter tester is available, test motor as described in paragraph 10-30.